



**OFFICE FOR HARMONIZATION IN THE INTERNAL MARKET
(TRADE MARKS AND DESIGNS)**

OPERATIONS DEPARTMENT – DESIGNS SERVICE

**DECISION OF
THE INVALIDITY DIVISION
OF 15/05/2013**

**IN THE PROCEEDINGS FOR A DECLARATION OF INVALIDITY
OF A REGISTERED COMMUNITY DESIGN**

FILE NUMBER	ICD 8683
COMMUNITY DESIGN	001222905-0002
LANGUAGE OF PROCEEDINGS	English
APPLICANTS	Samsung Electronics Co. Limited Samsung Electronics Building, 1320-10 Seocho 2-dong, Seocho-gu Seoul 137-857 Republic of Korea Samsung Electronics GmbH Am Kronberger Hang 6 Schwalbach Am Taunus Hessen 65824 Germany
REPRESENTATIVE OF THE APPLICANTS	Simmons & Simmons LLP CityPoint, One Ropemaker Street EC2Y 9SS London United Kingdom
HOLDER	Apple Inc. 1 Infinite Loop 95014-2084 Cupertino California United States of America
REPRESENTATIVE OF THE HOLDER	BARDEHLE PAGENBERG PARTNERSCHAFT PATENTANWÄLTE, RECHTSANWÄLTE Postfach 86 06 20 81633 München Germany

The Invalidity Division,

composed of Ludmila Čelišová (rapporteur), Jakub Pinkowski (member) and Martin Schlötelburg (member), takes the following decision on 15/05/2013:

1. **The Application for a declaration of invalidity of the registered Community design No 001222905-0002 is rejected.**
2. **The Applicants shall bear the costs of the Holder.**

I. FACTS, EVIDENCE AND ARGUMENTS

- (1) Community design No 001222905-0002 (hereinafter 'the RCD') has been registered in the name of the Holder with a date of filing of 01/07/2010 and the date of priority 06/01/2010 claimed from the US design patent application No 29/353,307. In the RCD, the indication of products reads 'portable display devices'. The design was published in the Community Designs Bulletin in the following views:

http://oami.europa.eu/bulletin/rcd/2010/2010_232/001222905_0002.htm

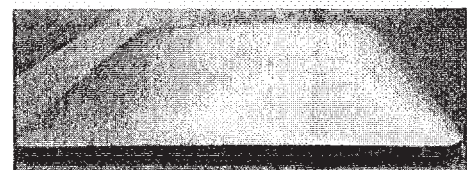
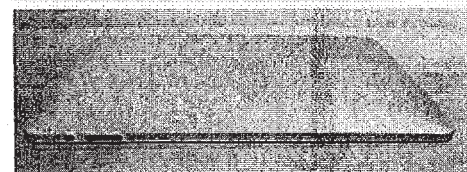
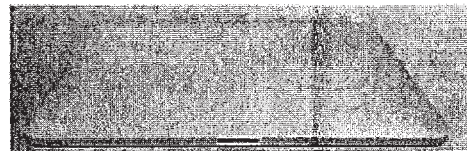
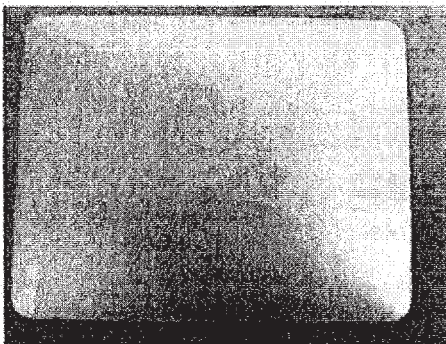
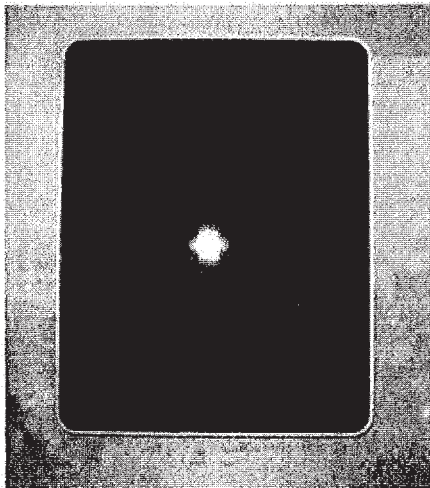

- (2) On 27/02/2012, the Applicants filed an application for a declaration of invalidity ('the Application'). The fee for the Application was paid from the current account. In the Application the Applicants requested, pursuant to Article 54 CDR, to be joined as parties to the invalidity proceedings file number ICD 8453 concerning the contested RCD. On 05/04/2012 Samsung Electronics Iberia SA filed an invalidity application (file number ICD 8730) and requested to be joined as a party to the same invalidity proceedings.
- (3) On 04/06/2012 the Office informed the parties that invalidity proceedings file numbers ICD 8453, ICD 8683 and ICD 8730 would be dealt with as one set of proceedings pursuant to Article 32(1) CDIR¹. On 27/11/2012 the Office decided pursuant to the same provision to no longer deal with application file number ICD 8453 this way and to deal with this application separately from the two latter applications.
- (4) Using the Office form for the application, the Applicants request a declaration of invalidity of the RCD on the grounds that the RCD does not correspond to the definition of a design under Article 3(a) of Council Regulation (EC) No 6/2002 on Community Designs (hereinafter 'CDR'), and it does not fulfil the requirements of Articles 4 to 9 CDR.
- (5) As evidence the Applicants provide, inter alia:
(please note that all images in this document are not necessarily to scale)
- a printout of US patent application No 2004/0041504 entitled 'Bezel-less Electronic Display', published on 04/03/2004 and containing images of the invention (hereinafter prior design D1, the Applicants' enclosure DAS-2), as follows:

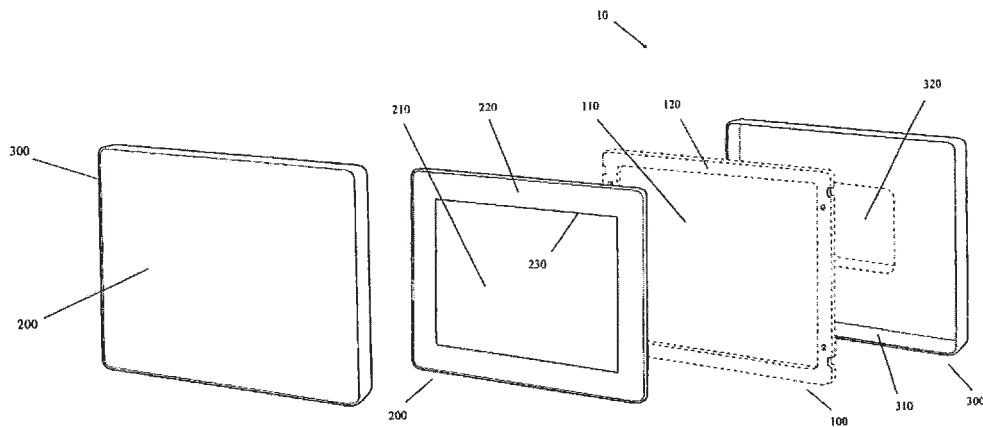

¹ Commission Regulation (EC) No 2245/2002 of 21 October 2002 implementing Council Regulation (EC) No 6/2002 on Community designs.

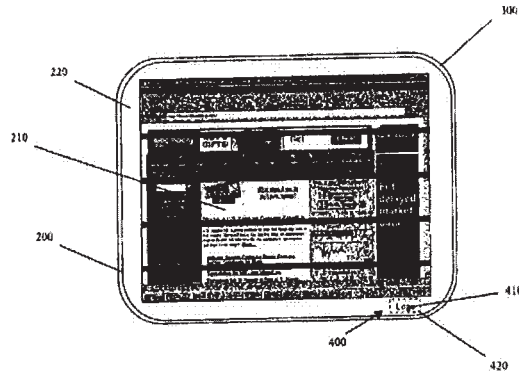
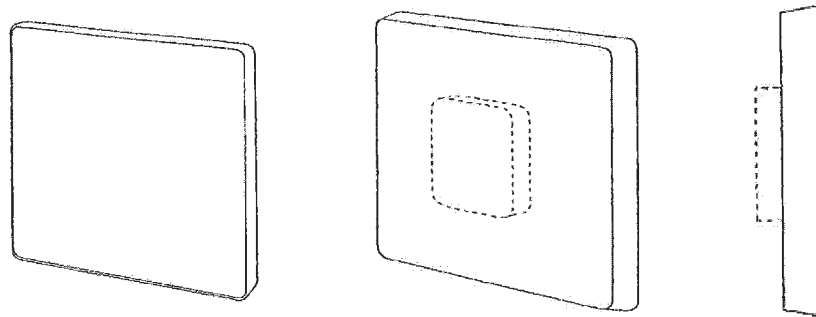
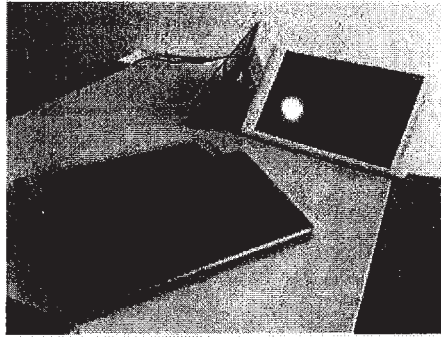

Fig. 5

- a printout of German design registration No 40301867-0001 entitled 'Flachbildschirm ohne Rahmen', published on 10/09/2003 and containing images of the design (hereinafter prior design D2, the Applicants' enclosure DAS-3), as follows:



- printouts of website www.monitor4u.co.kr containing date indications 2004-03-17, 2003-07-01 and 2011-10-18, and images of LG Flatron Tablet L 1530TM. A printout of the webpage www.heimkinomarkt.de containing a news article posted on internet on 25/03/2004, and an image of Flatron Tablet (hereinafter design D3). The Applicants further submit three detail images of LG Flatron Tablet L 1530TM (the Applicants' enclosures DAS-4, 5);
- a printout of a news article posted on website www.engadget.com on 06/01/2010, entitled 'The PH Slate' and 'HP's Windows 7 Slate Device Revealed by Steve Ballmer', containing information on release of Hewlett-Packard Slate tablet at the Consumer Electronics Show 2010, and images of the tablet (hereinafter design D4, the Applicants' enclosure DAS-6);
- a printout of a news article posted on website www.techlahore.com on 08/11/2009, entitled 'China's Boeye releases 'Apple tablet' before Apple can – TechLahore@GITEX', containing information on release of BoEye MID700 tablet at the GITEX trade show in Dubai, and the images of the tablet (hereinafter design D5), printouts of websites www.engadget.com of 11/11/2009 and www.pocketables.net containing the same images (the Applicants' enclosure DAS-7);
- printouts of news articles posted on internet from 21/07/2008 to 07/12/2009, containing information on release of Joojoo Crunchpad during 2009 and the images of Crunchpad (hereinafter referred as prior designs D6a (red) and D6b, the Applicants' enclosure DAS-8), as follows:



D6a (red)

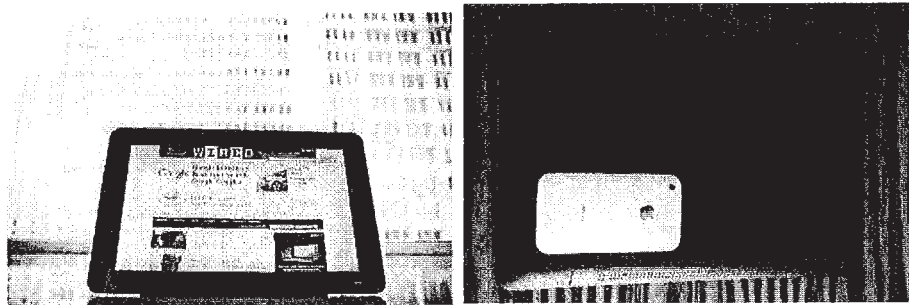

D6b

- a printout of Community design registration No 000181607-0001 entitled 'Handheld Computer', published on 10/08/2004, and a printout of US design patent No D504,889 entitled 'Tablet', published on 10/05/2005; both the disclosures containing the same design in the following views (hereinafter prior design D7, the Applicants' enclosures DAS-9, DAS-46):

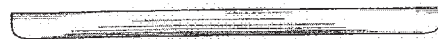
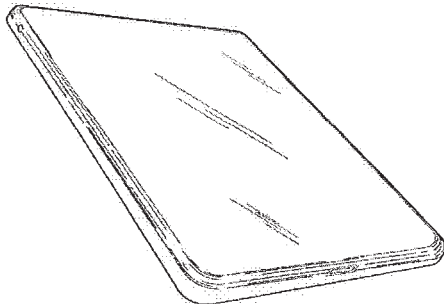
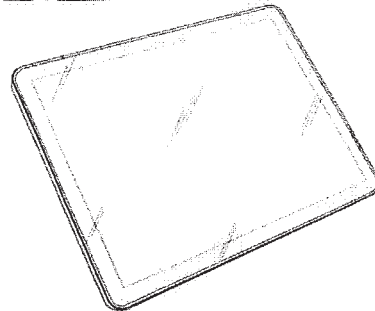
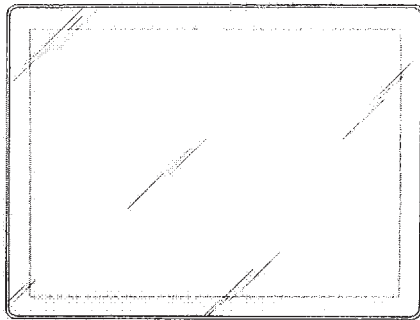

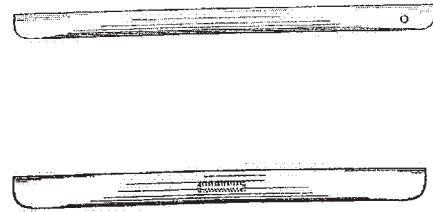
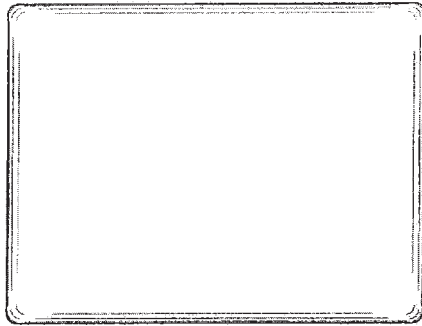

- a printout of UK design registration No 3,014,024 published on 27/10/2003 containing the design in the following views (hereinafter prior design D8, the Applicants' enclosure DAS-11):

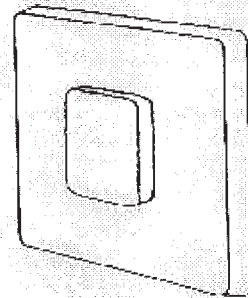
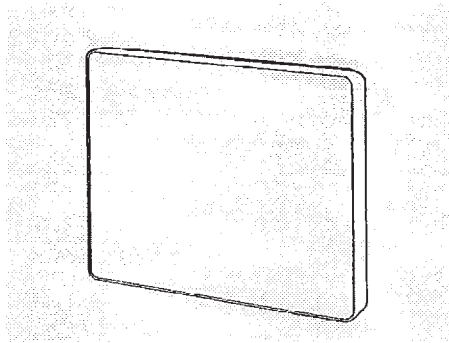

- a printout of a news article posted on website www.engadget.com on 08/01/2010, entitled 'MSI shows off 10-inch Android tablet running new Tegra chipset', containing information on the release of MSI 10-inch tablet at the Consumer Electronics Show (CES) in 2010, and images of the tablet (hereinafter design D9, the Applicants' enclosure DAS-12);
- a printout of Community design registration No 000048061-0001 entitled 'Computer Screens' 'Computer Monitors', published on 19/08/2003 (hereinafter prior design D10, the Applicants' enclosure DAS-13), as follows:

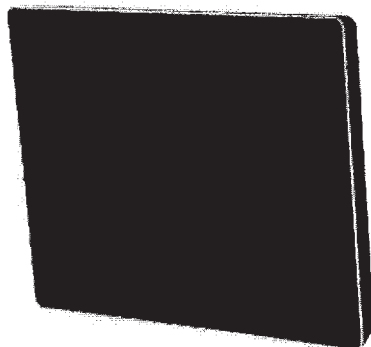

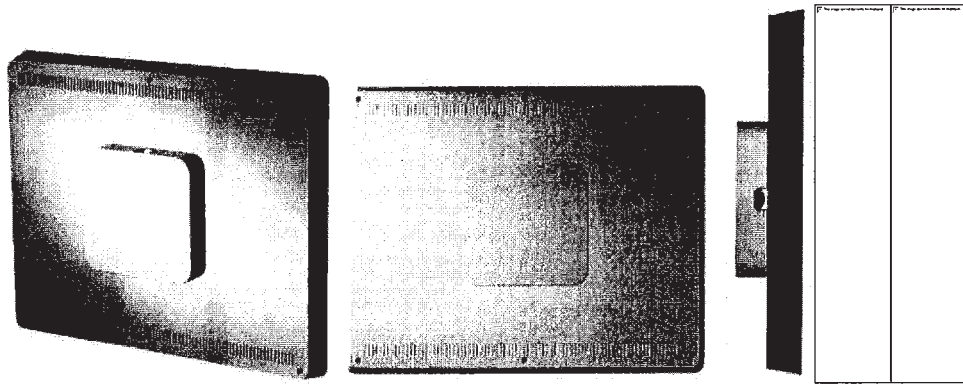

- a printout of international patent application WO 2004/023,272 A2 entitled 'Bezel-less Electronic Display', published on 18/03/2004, containing the images of the invention (hereinafter prior design D11, the Applicants' enclosure DAS-14), as follows:

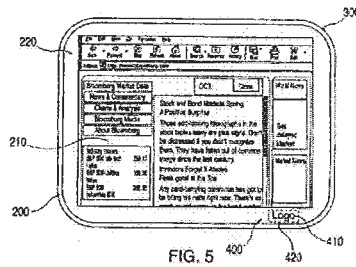
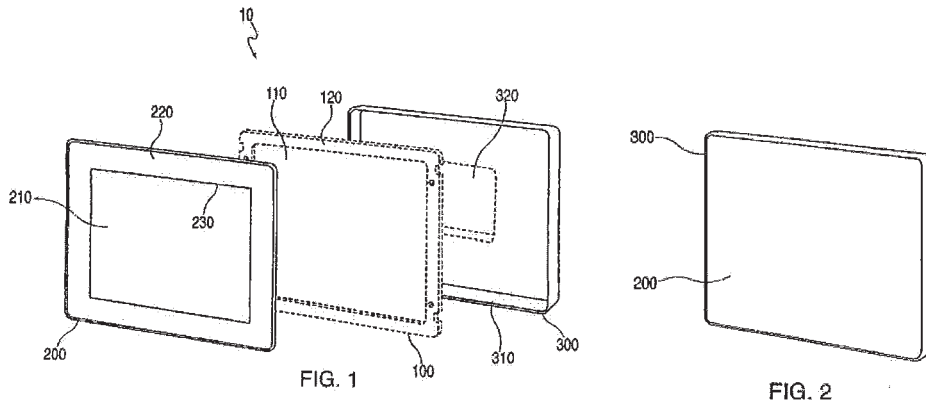

- printout of US design patent No D492,684 entitled 'Bezel-less Electronic Display', published on 06/07/2004 containing the following images of the design (hereinafter prior design D12, the Applicants' enclosure DAS-15):

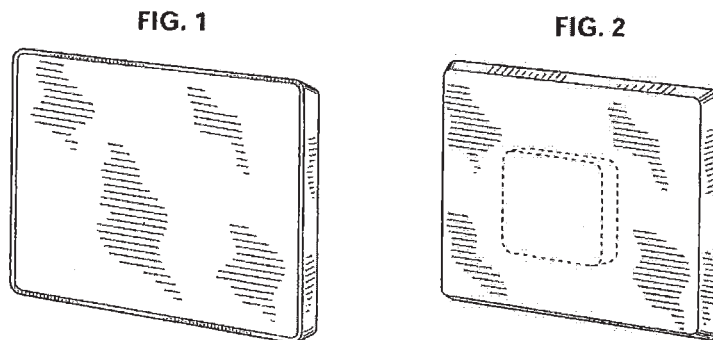

- printouts of news articles posted on website www.engadget.com on 09/11/2009, containing an image of NVIDIA ICD Vega tablet, the website www.engadget.com of 13/11/2009 containing an image of Vega tablet, the website www.nexus404.com of 13/11/2009 containing an image of ICD Vega tablet, and the website www.de.engadget.com of 28/11/2009 containing video of NVIDIA Tegra Tablet Prototype ICD Vega the screenshots of which are shown as prior design D13 below. (the Applicants' enclosure DAS-16):

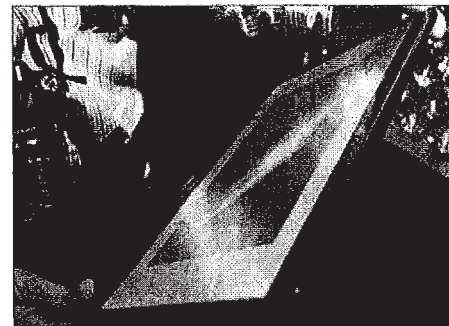
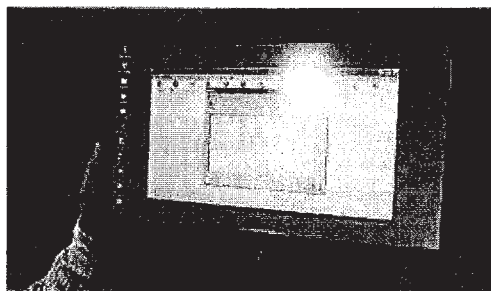
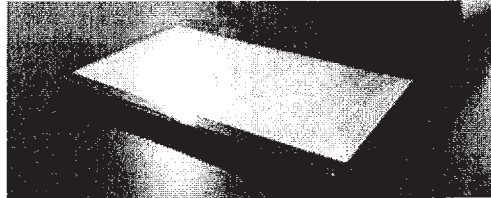

- a copy of the witness statement given by Roger Fidler in the proceedings between the Holder and the second Applicant in the United States, containing information on the release of '1981 Fidler Tablet' in 1981. The Applicants attach images of the tablet (hereinafter prior design D14, the Applicants' enclosure DAS-17), as follows:

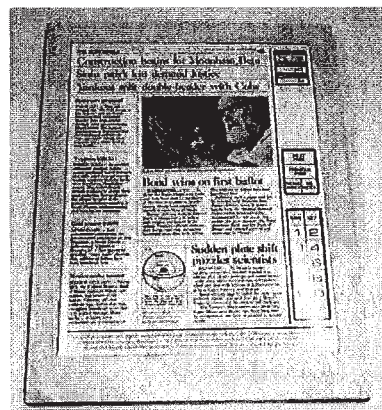

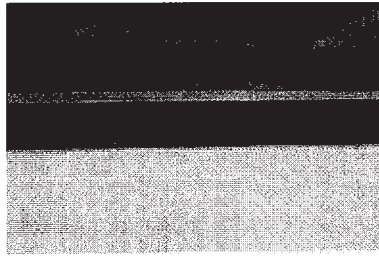

- images of '1994 Fidler Tablet' (hereinafter prior design D15, the Applicants' enclosure DAS-18) as shown below, which was, according to Roger Fidler's witness statement (the Applicants' enclosure DAS-17), released in 1994 followed by an introduction movie distributed in 1994:

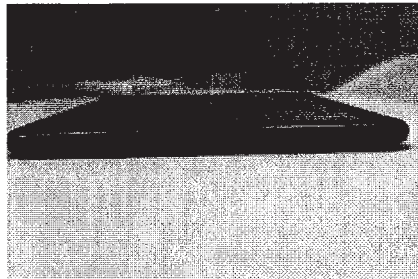
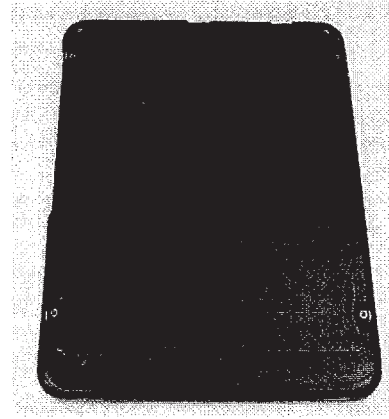

D15

- a printout of US design patent No D602,488 entitled 'Electronic Book' (hereinafter prior design D16, the Applicants' enclosure DAS-19), published on 20/10/2009 in the following views:

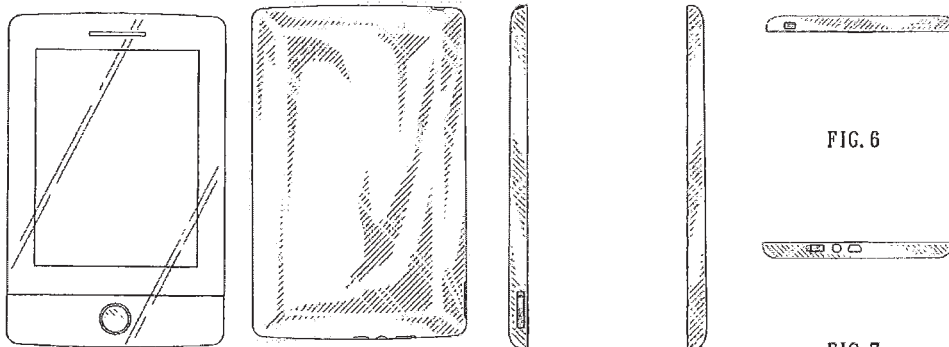
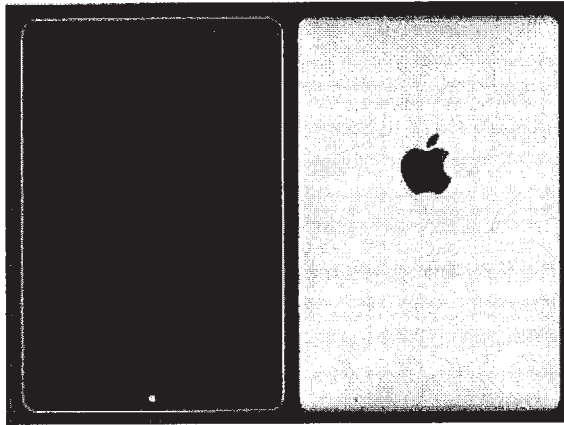

FIG. 6

FIG. 7

- printouts of news articles posted on various websites between 12/03/2009 and 27/11/2009, containing representations of Apple Touch Screen Netbook Prototypes and mock-ups of Apple devices as follows (hereinafter referred as prior designs D17a-f, the Applicants' enclosure DAS-20):



D17a

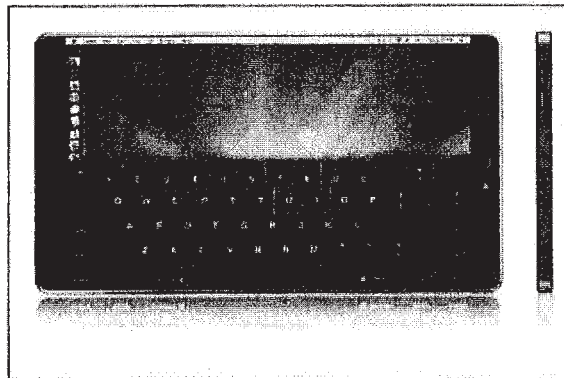

D17b

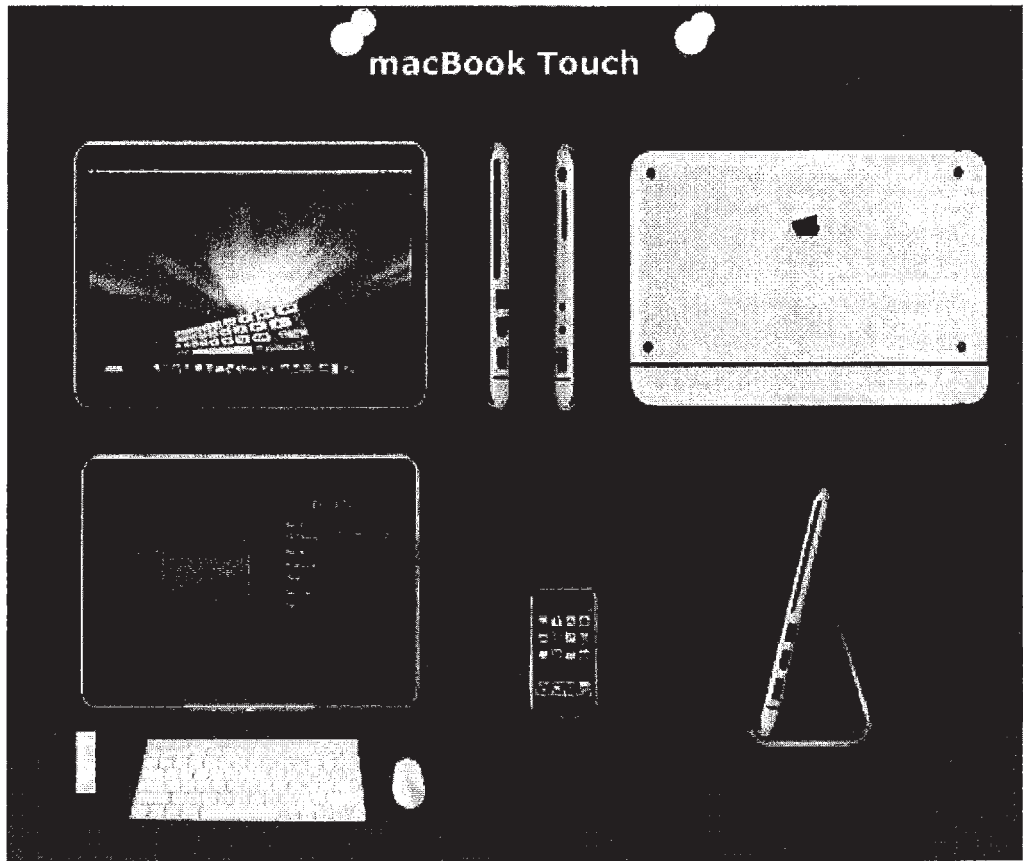

D17c

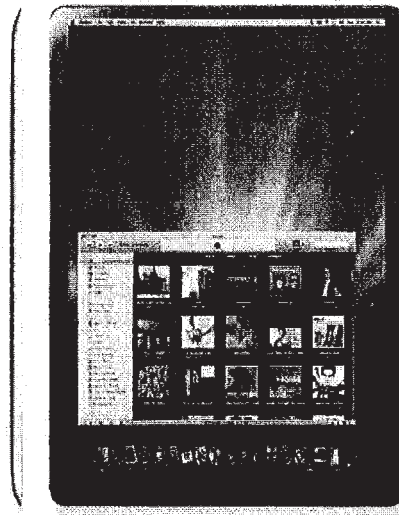

D17d

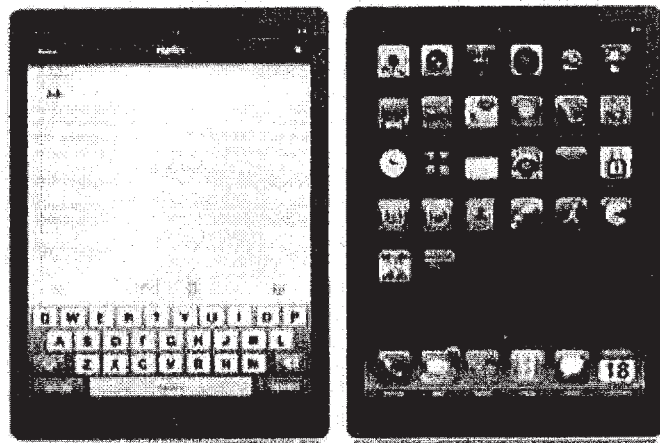

D17e

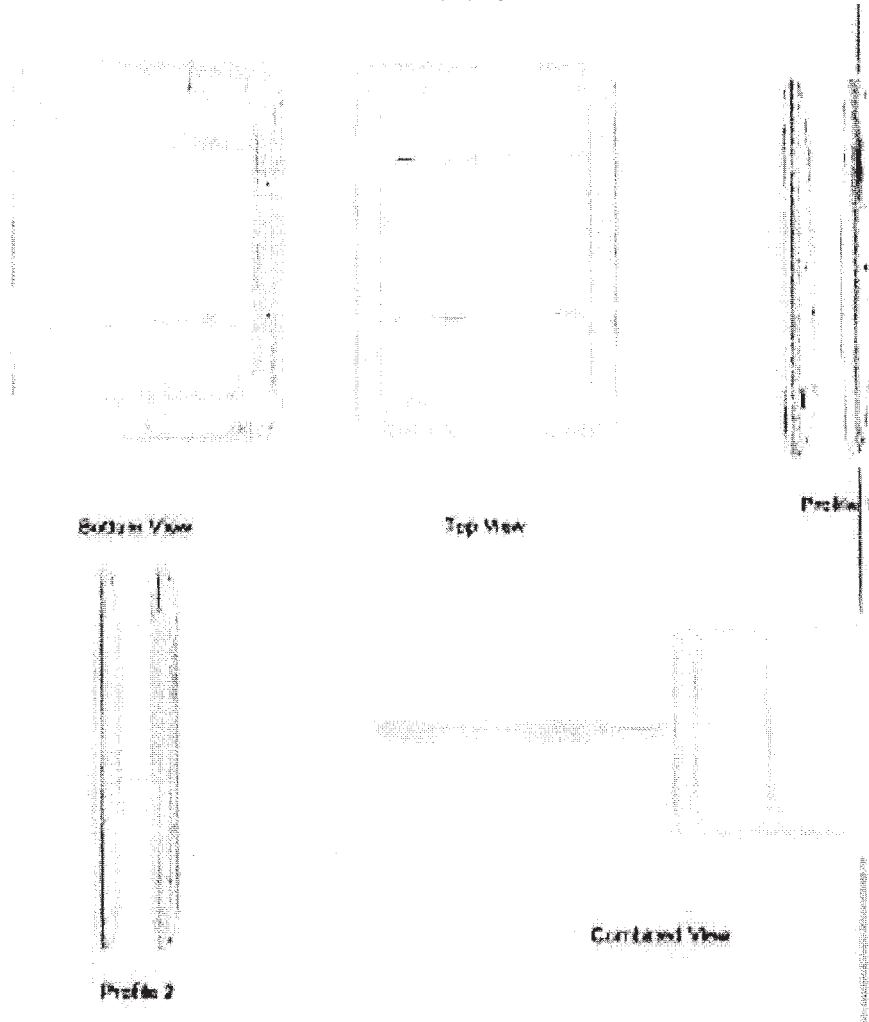

D17f (for better pictures see the documents on file)

- printouts of news articles posted on the website www.pencomputing.com in the December-2002 issue, the website www.PCMag.com on 08/03/2003, and the website of the Chicago Athenaeum Museum of Architecture and Design, informing on release of HP/Compaq TC1000 tablet in 2003, and

containing images of the tablet (hereinafter prior design D18, the Applicants' enclosure DAS-21), as follows:

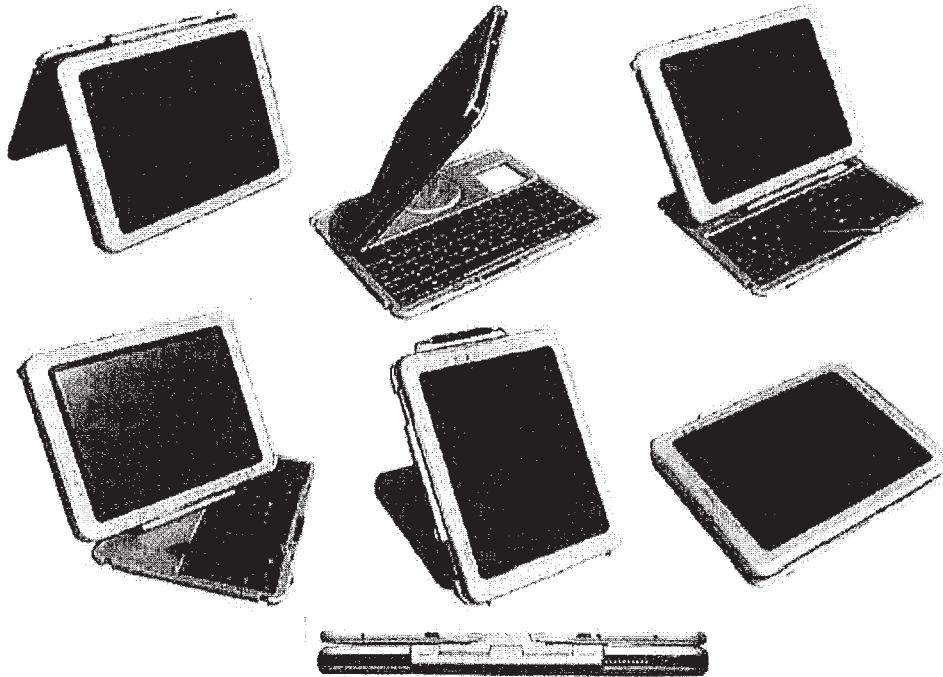

- a printout of Community design registration No 000401898-0003 entitled 'Television Apparatus', published on 21/02/2008 (hereinafter prior design D19, the Applicants' enclosure DAS-22), as follows:

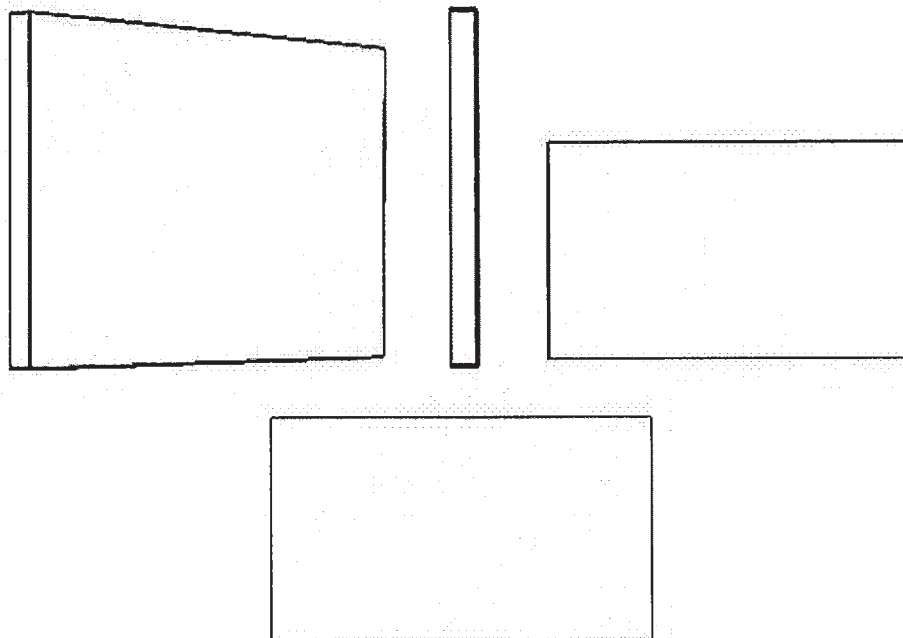

- a printout of stills of Knight-Ridder Inc. promotional film 'The Tablet Newspaper: A Vision for the Future', released in 1994 and containing images of the Tablet Newspaper (hereinafter prior design D20, the Applicants' enclosure DAS-23), as follows:



- a printout of a website of Stanley Kubrick's film '2001: A Space Odyssey' containing a still photograph of actors using a tablet computer or display screen (hereinafter design D21, the Applicants' enclosure DAS-24);
- a printout of UK design registration No 1,042,780 entitled 'A Memory Card for Electronic Pocket Notebook', published on 16/09/1988 (hereinafter prior design D22, the Applicants' enclosure DAS-25), as follows:

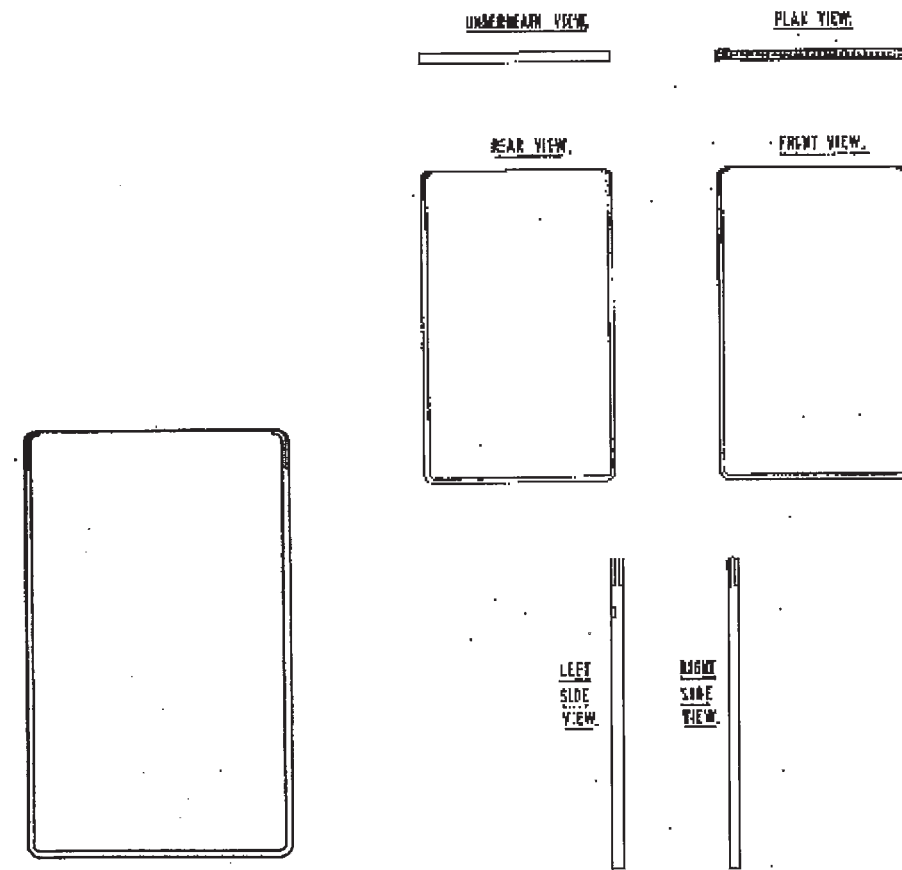

- a printout of US design patent No D306,583 entitled 'Radio Transceiver Housing or Similar Article', published on 13/03/1990 (hereinafter prior design D23, the Applicants' enclosure DAS-26), as follows:

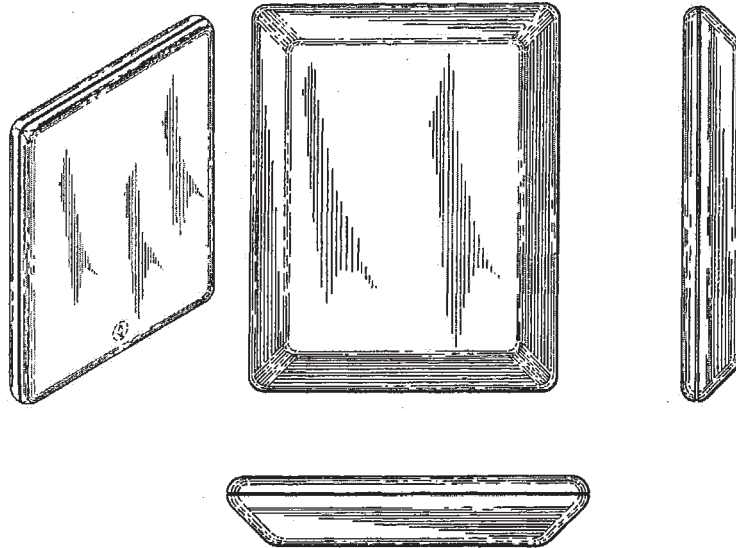

- a printout of UK design registration No 2,030,050 entitled 'Screen for Computer Display Device', published on 28/07/1993 (hereinafter design D24, the Applicants' enclosure DAS-27);
- a printout of Swedish design registration No 55,044 entitled 'Bildskärmsskydd', published on 27/10/1993 (hereinafter prior design D25, the Applicants' enclosure DAS-28), as follows:

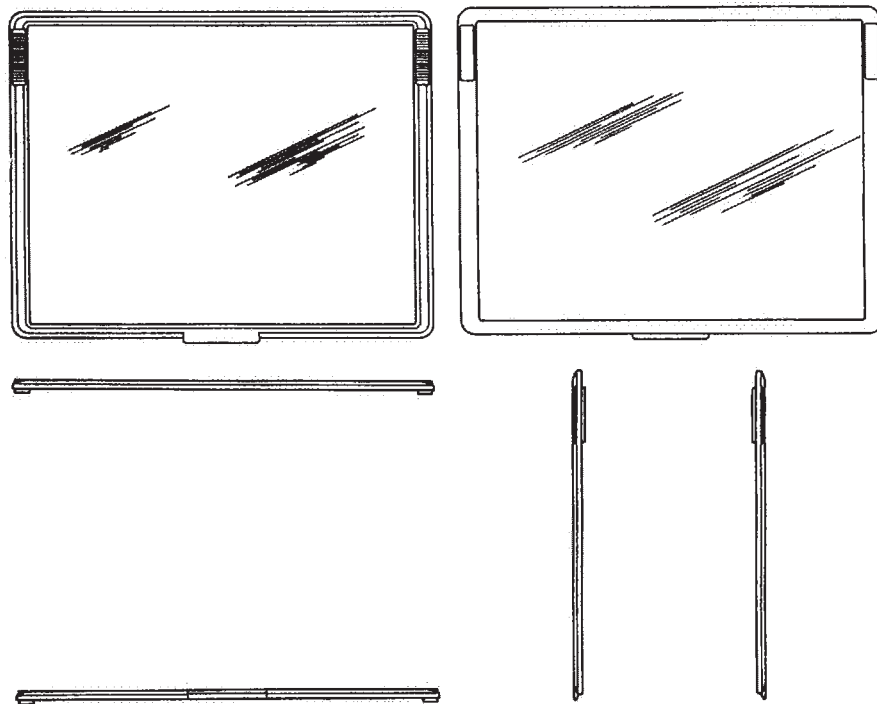

- a printout from the website www.amazon.co.uk showing a cover of the book 'Developing Tablet PC Applications', which was published on 12/11/2003. The cover contains an image of a tablet computer (hereinafter design D26, the Applicants' enclosure DAS-29);

- a printout of US patent No 5,345,543 entitled 'Method for Manipulating Objects on a Computer Display', published on 06/09/1994 (hereinafter design D27, the Applicants' enclosure DAS-30);
- a printout of Japanese design patent No 921403, published on 09/03/1995 (hereinafter prior design D28, the Applicants' enclosure DAS-31), as follows:

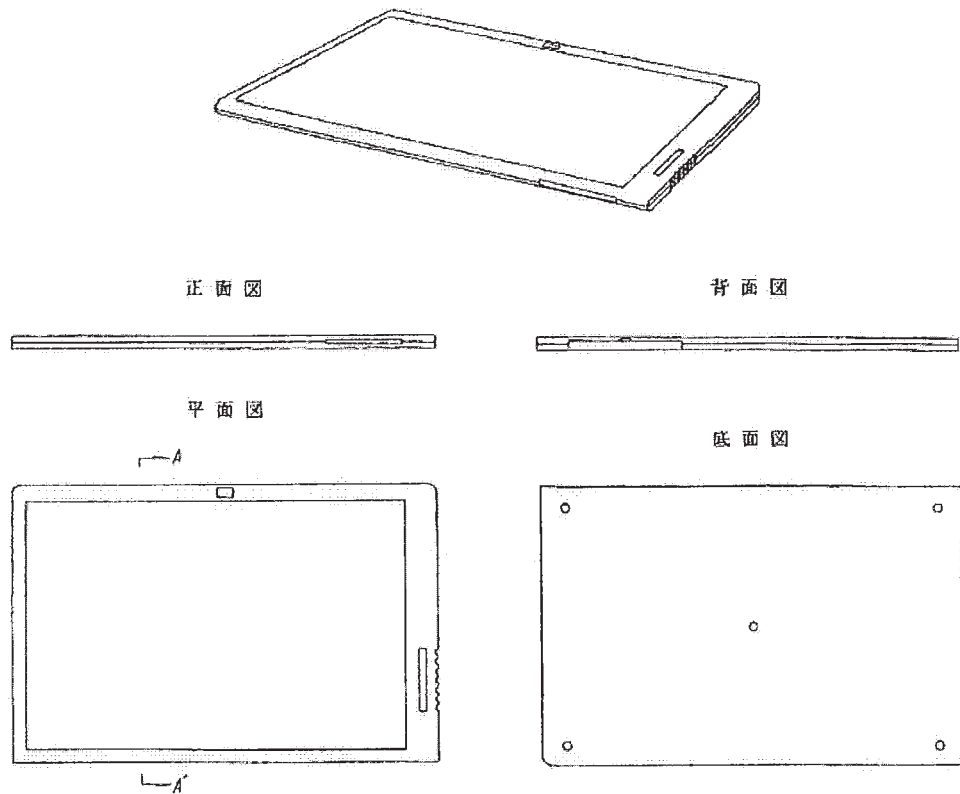

- a printout of Canadian design registration No 89155 entitled 'Data Display Unit', published on 31/03/2000 (hereinafter prior design D29, the Applicants' enclosure DAS-32), as follows:

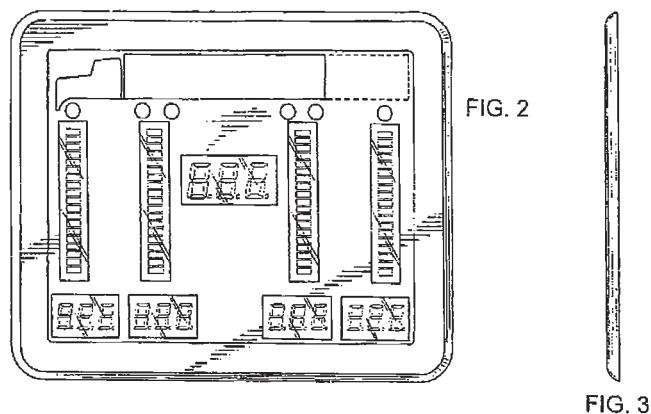

- a printout of a review posted on website www.macworld.com on 01/02/2001, containing information on the release of Wacom PL-500 interactive pen display in 2000, and an image of the display (hereinafter design D30, the Applicants' enclosure DAS-33);

- a printout of international patent application WO 2000/074240 entitled 'Keyboard System with Automatic Correction', published on 07/12/2000 as follows (hereinafter design D31, the Applicants' enclosure DAS-34);
- a printout of Japanese design patent No D1104685, published on 26/03/2001 (hereinafter prior design D32, the Applicants' enclosure DAS-35), as follows:

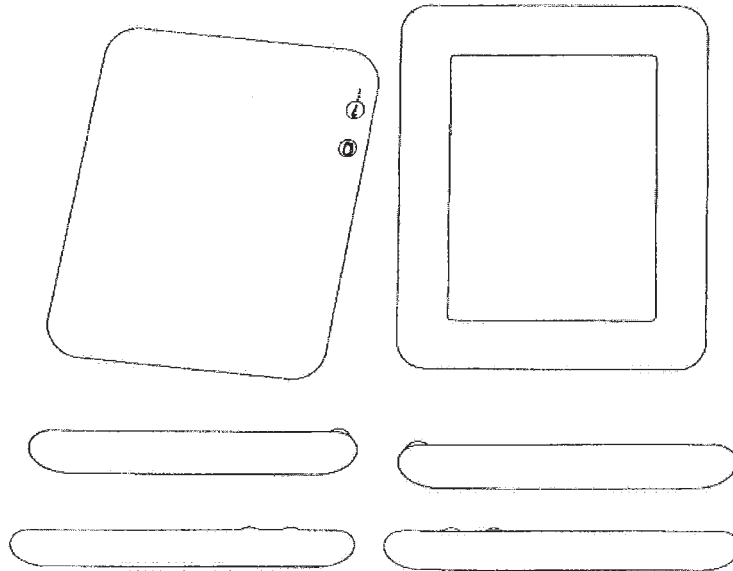

- a printout of Japanese Design Patent No D1124750, published on 29/10/2001 (hereinafter prior design D33, the Applicants' enclosure DAS-36), as follows:

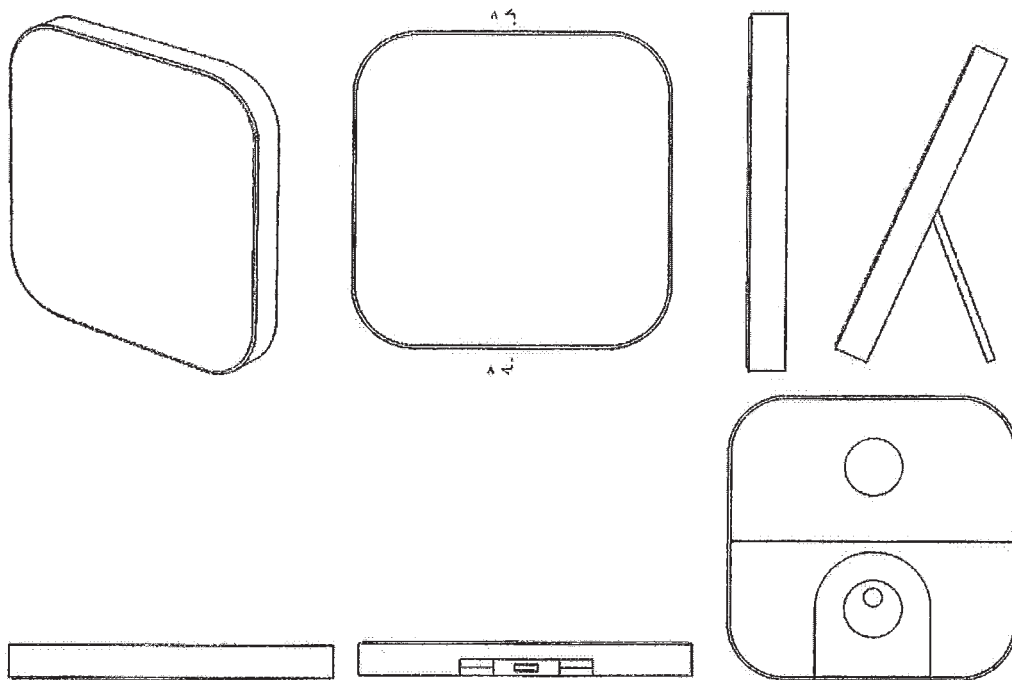

- a printout of a news article posted on website www.chip.de on 13/03/2002, containing information on the release of Microsoft Mira Tablet in 2002, and images of the tablet (hereinafter design D34, the Applicants' enclosure DAS-37);

- a printout of Japanese design patent No D1142127, published on 27/05/2002 (hereinafter prior design D35, the Applicants' enclosure DAS-38), as follows:

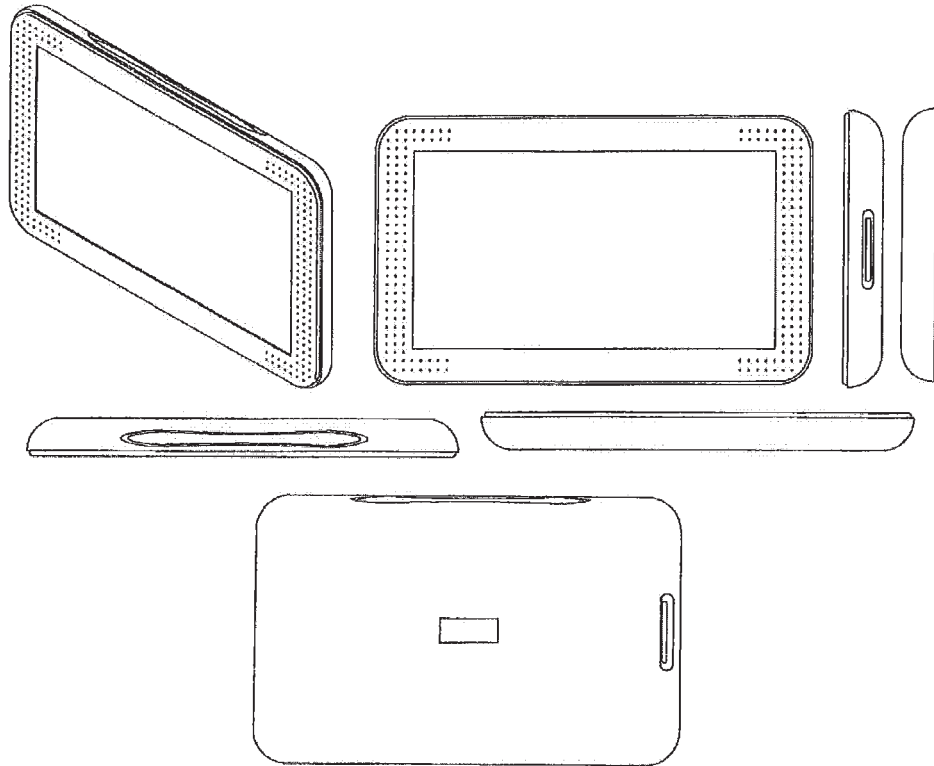

- a printout of Korean design No 30-0304213, published on 16/08/2002 (hereinafter prior designs D36, the Applicants' enclosure DAS-39), as follows:

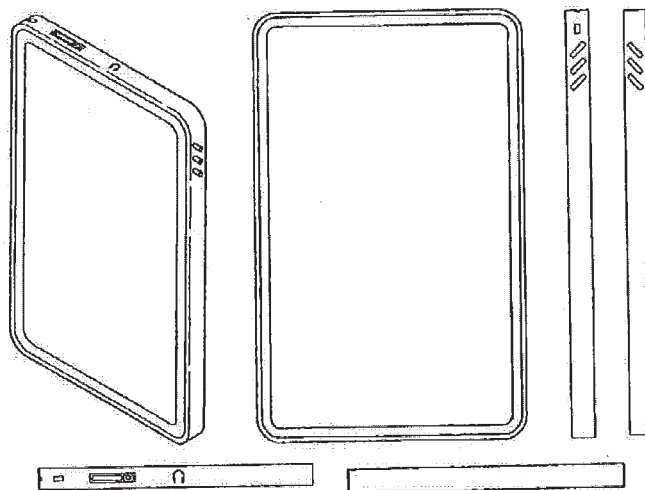

- a printout of US design patent No D461,802, entitled 'Tablet', published on 20/08/2002 (hereinafter prior design D37, the Applicants' enclosure DAS-40), as follows:

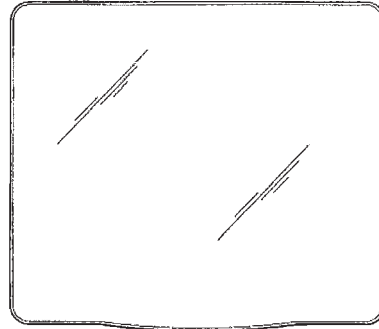
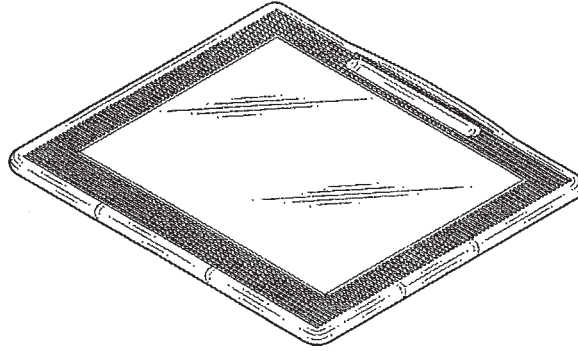

- a printout of a review posted on website www.pencomputing.com in December 2002, containing images of the Motion Computing M1200 tablet computer (hereinafter prior design D38, the Applicants' enclosure DAS-41), as follows:

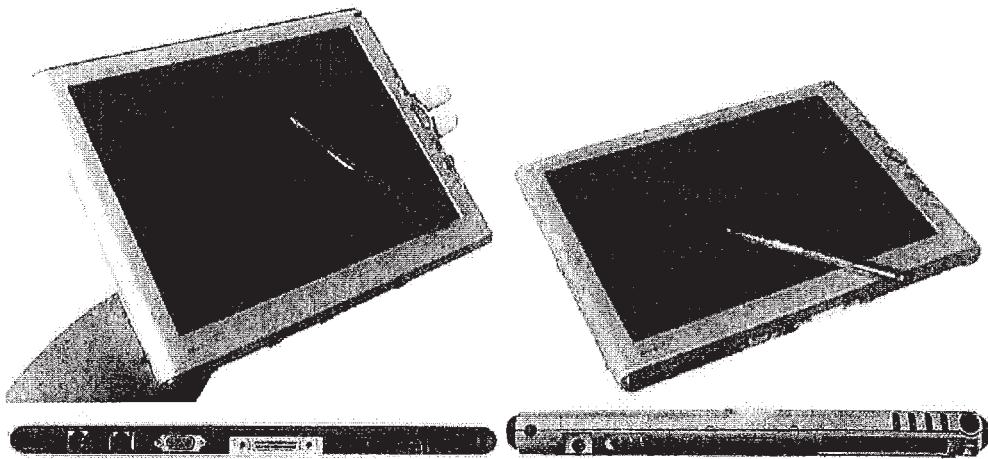

- a printout of a news article posted on website www.theapplecollection.com on 01/04/2003, containing images of the Powerpad G3 mock-up (hereinafter design D39, the Applicants' enclosure DAS-42);
- a printout of a news article posted on website www.theapplecollection.com on 15/06/2003, containing images of the Mypal mock-up (hereinafter design D40, the Applicants' enclosure DAS-44);
- a printout of a news article posted on website www.theapplecollection.com on 01/04/2003, containing images of Powerpad 2 (hereinafter prior design D41, the Applicants' enclosure DAS-43), as follows:

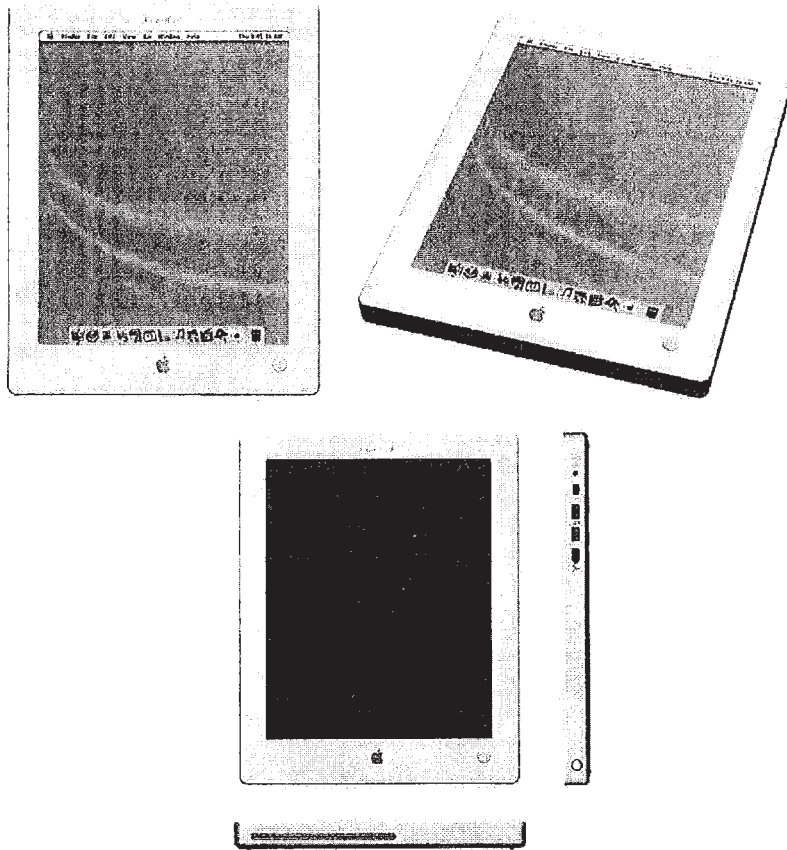

- a printout of Community design registration No 00046198-0001 entitled 'Tablet PCs', published on 11/11/2003 (hereinafter prior design D42, the Applicants' enclosure DAS-45), as follows:

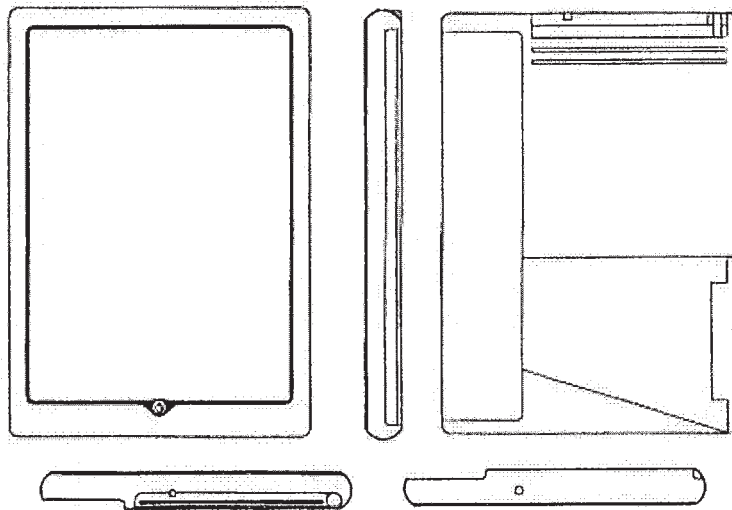

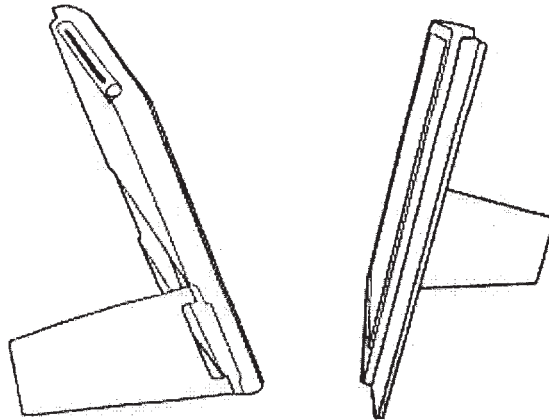

- a printout of Community design registration No 000328265-0001 entitled 'Tablet PCs', published on 14/06/2005 (hereinafter prior design D43, the Applicants' enclosure DAS-47), as follows:

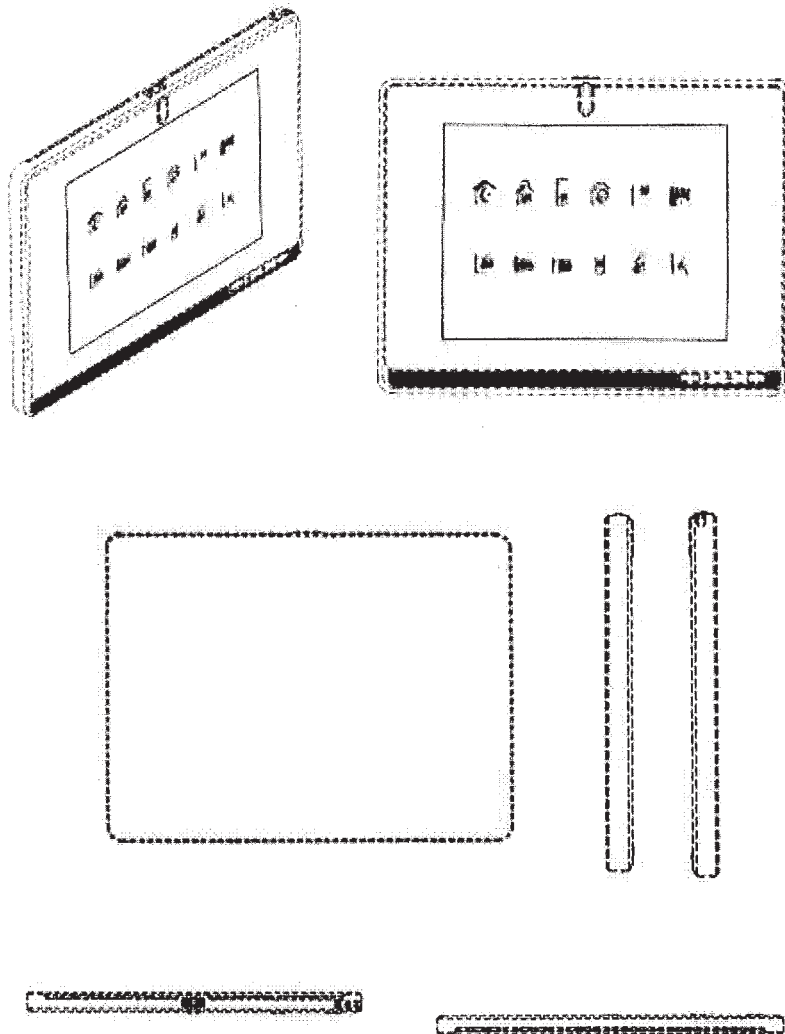

- a printout of the website www.engadget.com of 09/03/2006, containing images of the Samsung's picture frame (hereinafter prior design D44, the Applicants' enclosure DAS-48), as follows:



- a printout of a news article posted on website www.engadget.com on 29/11/2006, containing images of Philips PET830 and PET1030 media players (hereinafter designs D45, the Applicants' enclosure DAS-49);
- a printout of a news article posted on website www.tabletpreview.com on 15/04/2008, containing images of ElectroVaya Scribbler SC4000 (hereinafter prior design D46, the Applicants' enclosure DAS-50), as follows:

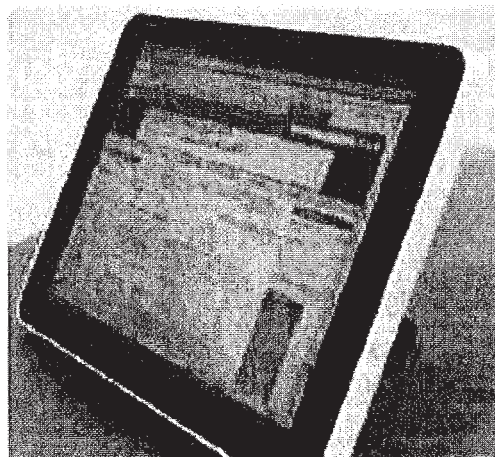
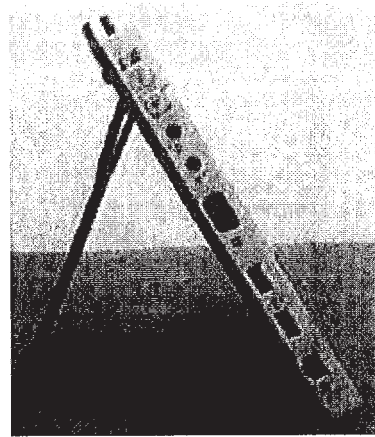
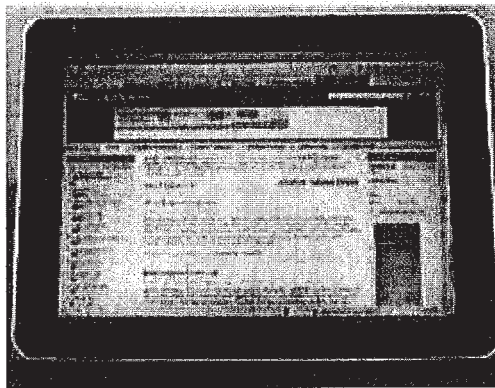

Left side view. (view large image)



Front view. (view large image)



Right side view. (view large image)



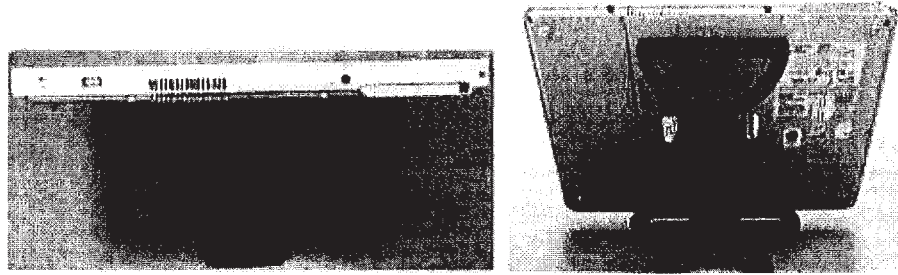

- a printout of Community design registration No 000891809-0003 entitled 'Information Terminals', 'Portable Terminals', published on 22/04/2008 (hereinafter prior design D47, the Applicants' enclosure DAS-51), as follows:

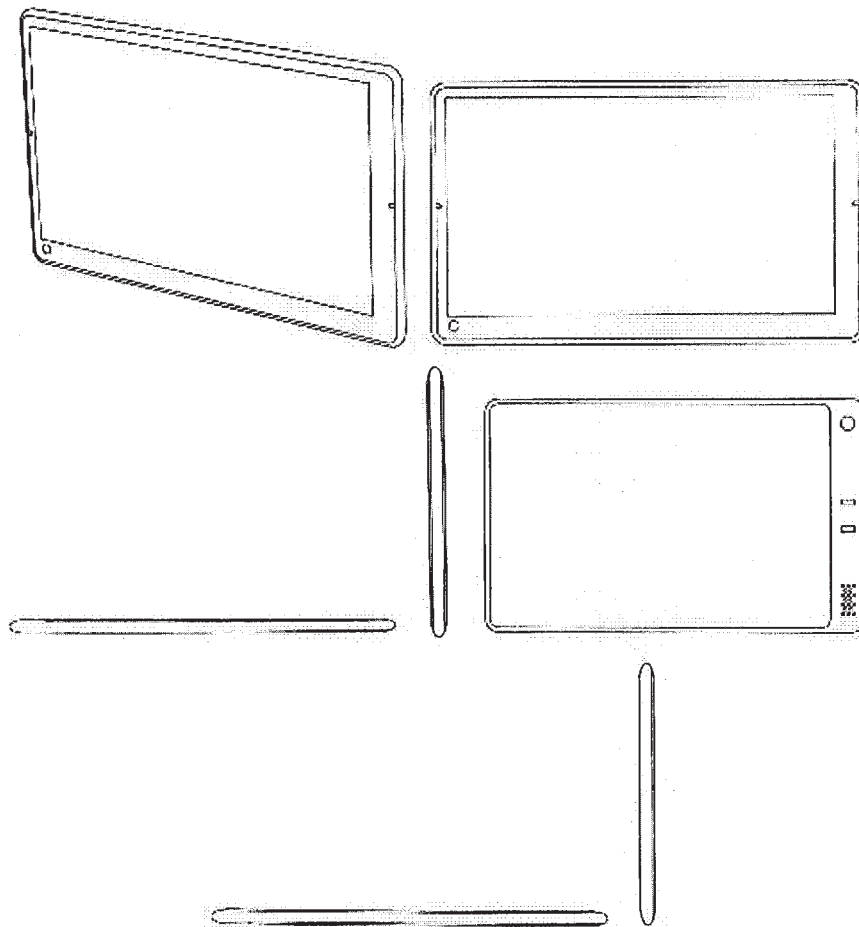

- a printout of German design registration No 40705936-0001 entitled 'Datenverarbeitungsanlagen sowie periphere Geräte und Einrichtungen', published on 09/05/2008 (hereinafter design D48, the Applicants' enclosure DAS-52);
- a printout of Community design registration No 001005839-0007 entitled 'Displays', published on 25/03/2009 (hereinafter prior design D49, the Applicants' enclosure DAS-53), as follows:

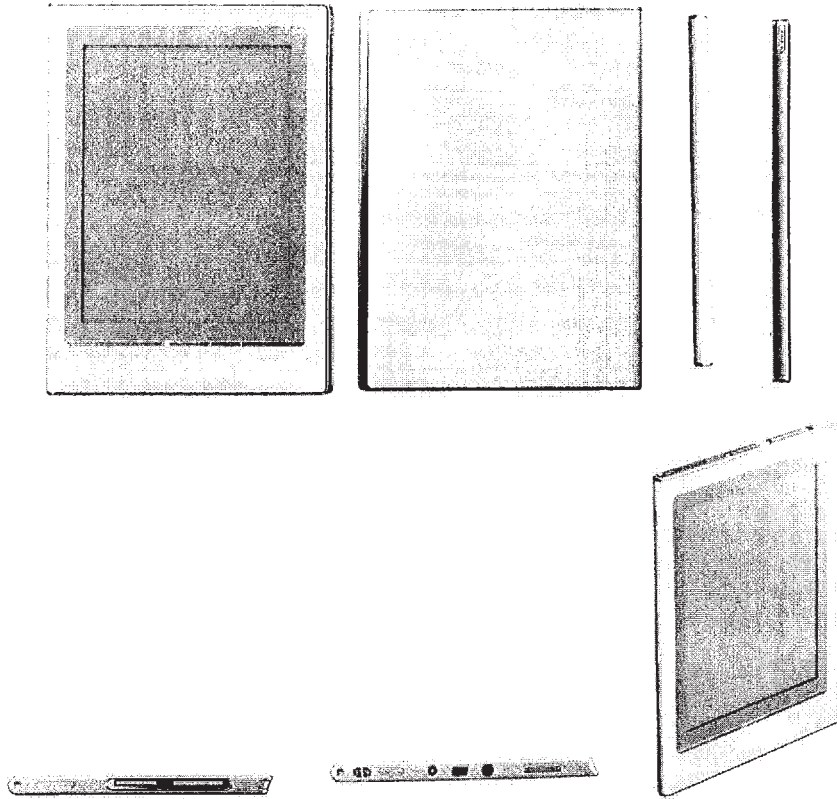

- a printout of Community design registration No 001143010-0005 entitled 'Interactive Boards', published on 10/07/2009 (hereinafter prior design D50, the Applicants' enclosure DAS-54), as follows:

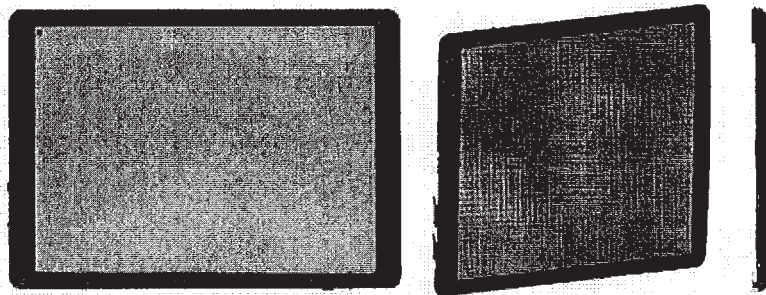

- a printout of Community design registration No 001214290-0003 entitled 'Web Books', published on 10/06/2010 (hereinafter design D51, the Applicants' enclosure DAS-55);
- a printout of Community design registration No 001098149-0001 entitled 'Electronic Devices', published on 06/04/2009 (hereinafter design D52, the Applicants' enclosure DAS-56);
- a printout of Community design registration No 001098149-0005 entitled 'Electronic Devices', published on 06/04/2009 (hereinafter design D53, the Applicants' enclosure DAS-57);
- a printout of Community design registration No 001677816-0002 entitled 'Handheld Computer', 'Handheld Computing Devices', 'Handheld Electronic

Devices', 'Media Devices', published on 23/04/2010 (hereinafter design D54, the Applicants' enclosure DAS-58).

- (6) In the reasoned statement, the Applicants submit that the priority claim from US design patent application No 29/353,307 is not in respect of the same design according to Article 41(1) CDR, because the design patent granted based on the application (US Design Patent No D627,777) contains drawings instead of coloured photographs and functional elements (ports and buttons) are disclaimed from the protection. The priority claim thus should be disallowed, and the relevant date for assessment of validity should be 01/07/2013 instead of 06/01/2010.
- (7) As regards the invalidity ground pursuant to Article 25(1)(a) CDR, the Applicants hold that the registration of the contested RCD is patently unclear and inconsistent because the first view shows a white blob at the centre of the screen of the device, which is not present in the remaining six views.
- (8) As regards the invalidity ground pursuant to Article 25(1)(b) CDR, the Applicants submit a number of designs which they allege were made available to the public prior to 01/07/2012. All the prior designs were disclosed in such a way that it could reasonably be expected to come to the attention of the circles concerned operating within the EU. Each of the submitted designs creates the same overall impression on the informed user as the RCD.
- (9) The informed user is the user of portable display devices, equipment for recording or reproduction of sounds or pictures, data processing equipment as well as peripheral apparatus and devices or communications equipment, wireless remote controls and radio amplifiers, which are the products of three subclasses of the International Classification for Industrial Designs in which the contested RCD was classified upon the request of the Holder for the registration of the design.
- (10) The Applicants further hold that not all features of the contested RCD should be given the same weight or should be considered at all in the assessment of individual character. According to the Applicants, supported by the witness statement of WooLong Lee, the Principal Engineer from the Patent & Technology Group of the first Applicant, the freedom of the designer of the given goods is limited by the following features:
 - the product must be made of durable metal or plastic,
 - the product must be light,
 - the display screen must be flat to avoid offering a distorted view and to allow easy cleaning as it is supposed to be operated by touching the display,
 - the product must be as thin as possible,
 - the sides of the product may contain metal as reinforcement in order to prevent damage,
 - the screen has to be as large as possible to maximise text/visual/gaming capacity, and the touch insensitive area framing the display area to allow hold the product without unwanted triggering the functions, must be strictly limited in width,
 - a rectangular shape makes it easy to read documents, it is familiar to consumers and it is favoured in the manufacturing process,
 - the corners must be rounded to avoid catching on clothing and being damaged during processing, assembly or handling,

- there will usually be at least one button (on/off) and potentially other buttons (volume etc.),
 - many such products now include a camera, and
 - many electronic devices require a connection so as to be recharged/powerd.
- (11) The Applicants conclude that the features of a product's appearance that were chosen exclusively for the purpose of designing a product that performs its function are not protectable. Designers of certain functional elements retain freedom to create distinctive designs, but less distinctive designs are less likely to create a different overall impression. The Applicants summarise that less importance and attractiveness towards the informed user will have features common to the design for the goods at issue, features not easily perceived by the informed user and similarities in respect of features imposed by design constraints in contrast to features where the designer was free to develop the design.
- (12) Regarding prior design D1 the Applicants hold that both the prior and the contested designs have a flat surface covering the front of the product, they concern a rectangular shaped object with evenly rounded corners, and they have a display screen under the clear surface and a band around the flat clear surface. Both the designs have a substantial border on all sides of the display screen. Therefore, the designs are identical pursuant to Article 5(2) CDR and they create the same overall impression on the informed user pursuant to Article 6 CDR.
- (13) Prior design D2 derives from the same priority document, as prior design D1, i.e. US design patent application 29/166,842. According to the Applicants the evidence concerning D1 and D2 appear to feature the same design. The back of prior design D2 appears to be without any elements as the protrusion appears to be disclaimed by dotted lines. The assessment of prior design D2 results in the same conclusions which are valid for prior design D1.
- (14) The Applicants further claim that prior designs D6, D13, D16 and D17 are very similar if not identical to the RCD. All the designs concern rectangular shaped objects with four evenly rounded corners. All of them have a flat surface covering the front of the product with a display under the clear surface. All have a band around the flat surface and a substantial border on all sides of the display screen. Accordingly, the designs are identical under Article 5(2) CDR and they create the same overall impression on the informed user under Article 6 CDR.
- (15) Regarding prior design D7 the Applicants state that the Holder characterised the prior design in another proceeding by the features of: an overall rectangular shape with four evenly rounded corners, a flat clear surface covering the front of the device, a centred rectangular frame under the clear surface, a thin rim surrounding the front surface, a back panel that is rounded at the corners and rounds up near the edges, and a thin profile. As the contested RCD contains all these features, it is identical with the prior design pursuant to Article 5(2) CDR and creates the same overall impression on the informed user.
- (16) In the rejoinder the Holder submits that the priority has been claimed properly because the priority application contained, inter alia, coloured drawings including the seven images in which the Community design is registered. The images of the contested RCD differ from the priority document images only in the 'Apple-Logo', which is placed in the centre of the casing and visible in rear and side views on the design in the priority document. This difference is, however,

immaterial in the sense of Article 5 CDR, and thus the RCD is identical with the design in the US design patent application. The logo must be disregarded anyway because it is not claimed as being part of the priority application.

- (17) According to the Holder evidence concerning D3 (DAS-4), D32 (DAS-35), D33 (DAS-36) and D35 (DAS-38) has to be disregarded because it was not filed in the language of proceedings and no translation was delivered within the prescribed time. The evidence concerning D22 (DAS-25), D25 (DAS-28), D28 (DAS-31), D32 (DAS-35), D33 (DAS-36) and D35 (DAS-38) contain neither official registration certificates nor identifiable extracts from official databases [i.e. the design databases of the Swedish, British and Japanese patent offices], and thus the evidence must be disregarded as well. Regarding D2 in DAS-3 only the first view was requested to be published by the German Patent and Trade Mark Office, and only this view can be taken into consideration. The other views of D2 are accessible only when inspecting the file. Enclosures concerning D27 (DAS-30) and D31 (DAS-34) do not show a design but a technical solution, namely a method of rotating an image on a screen, and a keyboard as a part of a touch-sensitive screen respectively, thus the overall impression produced by the cited designs will be different from the one produced by the RCD. Prior design D43 according to DAS-47 relates to the display area only, and the device, in which the display is incorporated, is completely disclaimed, thus there is no disclosure of a design of an electronic device.
- (18) The Holder further submits that the Applicants do not provide adequate evidence for demonstrating earlier disclosure of the prior designs. The witness statement of David Angus Stone must be disregarded as having a direct interest in the outcome of the proceedings, and any confirmation of facts included in the statement does not have any value as evidence. The disclosure of the prior designs on the internet could not reasonably have become known in the normal course of business to the circles specialised in the sector concerned, operating within the Community because of countless number of existing blogs and websites. Unlike published IP rights which can be easily searched, the knowledge contained in blogs or websites cannot be systematically searched and thus blog contributions are acts of publication that even attentive members of the trade circles in question could only have discovered by chance and, therefore, as such have to remain out of consideration. For this reason the designs and their evidence D4 (DAS-6), D5 (DAS-7), D6 (DAS-8), D9 (DAS-12), D13 (DAS-16), D17 (DAS-20), D21 (DAS-24), D30 (DAS-33), D39 (DAS-42), D41 (DAS-43), D40 (DAS-44), D44 (DAS-48), D45 (DAS-49) and D46 (DAS-50) shall be excluded from the assessment of novelty and individual character.
- (19) Evidence concerning D4 (DAS-6), D9 (DAS-12), D26 (DAS-29), D51 (DAS-55) and D54 (DAS-58) does not prove disclosure prior to the date of priority, and some designs referred to as D17, according to the evidence (DAS-20), were disclosed during the grace period of the contested RCD, and hence must be also disregarded.
- (20) According to the Holder the prior designs contained in DAS-20 are furthermore the subject of the exclusion pursuant to the Article 7(3) CDR. The article must be read the way that a disclosure shall not be taken into consideration for the purpose of applying Articles 5 (novelty) and 6 (individual character) if the design has been made available to the public as a consequence of an abuse in relation to the designer or his successor in title. The prior designs are obviously 'mock-ups' which are not based on any real products, and they were created by some obscure unidentified and unidentifiable bloggers by photomontages of various

other original products of the Holder. The designs are based on information from leaks in the Holder's group of companies and suppliers. It is typical that before any market launch of a new Apple product, countless images showing 'the new product' circulate on the internet. The reason for this is the high level of popularity of the Holder's highly innovative products. According to the information provided by the bloggers themselves, the basis for these assumed prototypes is mainly information that was supplied to the press by Apple suppliers and insiders without the Holder's consent.

- (21) The Holder further submits that the illustrations of the prior designs do not disclose sufficient details. The images of the prior designs provide a view of the design only from the front and thus they are incapable of challenging the individual character of the contested RCD and may not be taken into account. The individual character is assessed on the overall impression, which becomes clearer when looking at further views of the prior designs. As an example the Holder submits additional views of D6 and D44 (see paragraph 27 below).
- (22) Furthermore, the images of the prior designs disclose different versions or prototypes incorrectly presented as 'one design'. As the individual character cannot be denied on the basis of an overall view of a number of different designs, the individual prototypes have to be considered separately. It concerns evidence showing designs D17 (DAS-20), D6 (DAS-8) and D45 (DAS-49).
- (23) Consequently, D5, D6 (all four prototypes), D9, D17, D20, D21, D24, D26, D29 – D31, D34, D38 – D41 and D45 are per se not capable of challenging the individual character of the contested RCD. Should the Office consider the prior designs for the test of novelty and individual character, the Holder submits that the documents relating to them do not provide sufficient views and non-visible views or features must be deemed completely different than those provided by the RCD. Designs D3 – D6, D9, D13, D17, D20 – D22, D24 – D35, D38 – D41, D44 – D46, D51 and D54 do not form part of prior art for the reasons of obscurity or no disclosure in the relevant period.
- (24) Regarding the ground of invalidity pursuant to Article 25(1)(a) the Holder submits that the 'white blob' results from a flash photograph taken frontally and thus there is no inconsistency in the representations of the RCD. Even if this were so, the Office should grant the Holder the possibility to correct the representations rather than invalidate the RCD.
- (25) Regarding features of appearance dictated by technical function, the Applicants fail to provide any relevant facts or evidence to support this claim. The feature of durability of material and enforced casing made of metal claimed as being solely dictated by the technical function of the product must be dismissed because material is not claimed in the contested RCD. The claimed lightness of the product has no impact on the appearance of the product. Where various design alternatives with regard to features listed by the Applicants exist, particularly flatness of the product, size of the screen, rectangular shape, rounded corners and functional elements like buttons, cameras, etc., the creative freedom of the designer is demonstrated in prior art and thus such features are not solely dictated by the technical function of the product. According to case-law, the informed user pays particular attention to the specific appearance of any functional element.

- (26) Because the Applicants keep silent about the ground of novelty, the Holder assumes from the Applicants' submissions that they do not consider the prior designs to be identical to the RCD and hence the RCD is new.
- (27) Regarding the individual character, according to the Holder, the Applicants limit the assessment to the front view though the back view provides features that are protected by the contested RCD and thus must also be considered. The views, provided by the Holder as follows clearly demonstrate that merely taking into account the front view is insufficient in the assessment of individual character.

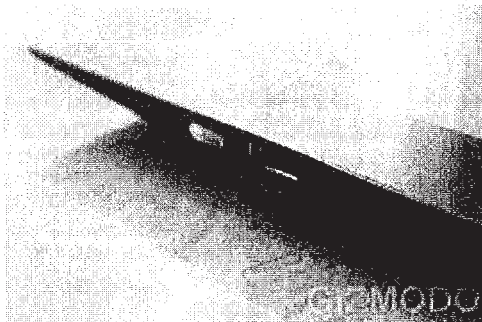
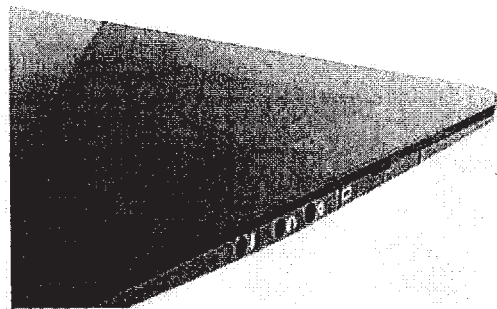
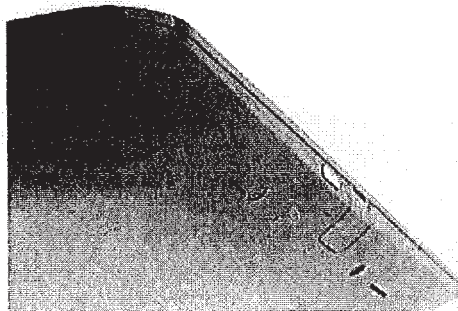
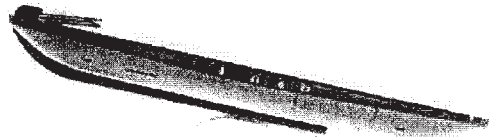
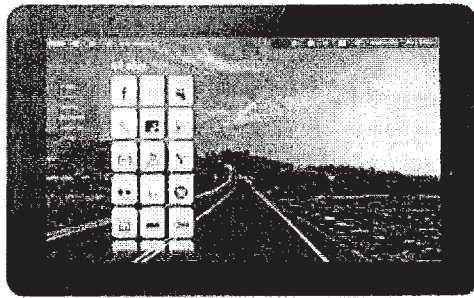

D6b

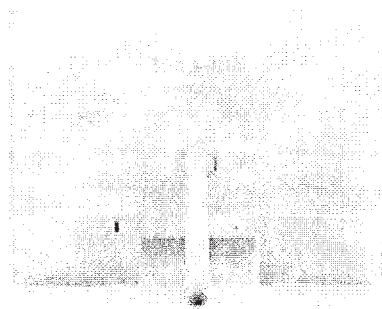

D44

- (28) According to the Holder, the contested RCD is a generally rectangular device that provides the appearance of minimal features, with a front display area having an overall flat appearance, and surrounded by a frame in a housing, the housing having side regions comprising a tapered portion and a substantially vertical portion that merges into a sloping rear portion of the housing. The assessment of individual character must be done side by side with the prior designs. The Applicants do not provide any such comparison, with the exception of a few words about D1 – D7, D13, D16 and D17. Apart from that, all the prior designs are missing some of the features present in the RCD or they include further additional features which do not form part of the contested RCD and thus the submission of a lack of individual character of the RCD is unfounded.
- (29) The Holder further submits visual and textual comparison of the prior designs. Only the comparison of the prior designs earlier provided by the Applicants is further summarised. For the comparison of the RCD with prior designs D9, D19, D23, D29, D33, D36, D43, D44, D46, D47, D48, D51, D52, D53 and D54, the reference is made to the documents on file.
- (30) According to the Holder, the overall impression of the prior design cannot be assessed from the evidence submitted for D1 because the drawings are contradictory alternative embodiments of a utility patent and they are merely schematic. The Applicants should not rely on the description of the invention, because under Article 36(6) CDR information contained in the description shall not affect the scope of protection of the design as such. Apart from that, in D1 there is no transparent front surface; instead there is an attachable surrounding chassis, a broad casing which makes the product box-shaped and bulky. In the design there are no side regions with a tapered portion and no sloping rear portion, but rather an opening in the back, and there are no contrasting surfaces. The same characteristics are valid for D2 and D11 and nearly the same applies to D8, D10 and D12.
- (31) The evidence submitted regarding D6 contains four different prototypes of product, in which the backs and sides are either missing or are different from the RCD and the designs have a chassis surrounding the screen instead of flat front (except the fourth prototype, which has a flat front but a bulky casing and no contrasting surfaces).
- (32) Regarding D13 the Holder submits that in contrast to the RCD it has a surrounding thin chassis that is raised relative to the display area, no side regions comprising tapered portions, no sloping rear portion, no contrasting surfaces, and additional features such as a round feature on the back.
- (33) Comparing D16 with the RCD, the Holder submits that it has the front providing a further part at the lower short side, no side vertical regions comprising a tapered portion and no thin rim but a rounded transition from the sides to the back, which is however flat without the sloping rear portion, and there are no contrasting surfaces applied on the design.
- (34) Regarding design D7 the Holder submits that the prior design differs from the contested RCD in various – missing or additional – features, which evidently do not form part of the contested RCD, e.g. no side regions comprising a tapered portion, a rounded transition from the narrow sides to the back, a flat back with rounding merely towards the narrow side, no contrasting surface.

- (35) The Holder concludes that all the compared prior designs produce an entirely different impression on the informed user from the impression produced on him by the contested RCD.
- (36) In reply to the Holder's observations, the Applicants submit that the date and images disclosed in documents in a language other than the language of the proceedings are not affected by this deficiency and only the texts should be disregarded. The date of publication of registered designs is identified by INID code 45 of WIPO standard ST.9, and all the evidence concerning registered designs originates from the official registers. The images and dates of online disclosures are relevant and the proof that a particular disclosure is too obscure to be excluded from the assessment of novelty and individual character pursuant to Article 7(1) CDR is on the Holder. It is difficult to conceive of any publication on the internet that would be too obscure, especially in a case about tablet computers. The circles specialised in this sector are particularly 'tech savvy' and information quickly percolates online. The circles specialised in this sector are also likely to be backed by significant commercial resources allowing them to keep abreast of developments in this highly competitive global industry. Large companies devote significant resources to monitoring competitors' designs. Moreover, the circles specialised in the sector concerned do not need to be aware of the article but the relevant events reported in the articles like marketing events, high-profile product launches etc. As the priority claim is invalid according to the Applicants, all disclosures are relevant.
- (37) Regarding the disclosure of the prior designs in DAS-20 the Applicants submit that the exception pursuant to Article 7(2) and (3) CDR relates to 'the design concerned', i.e. the contested RCD. The prior designs are not 'the same design', hence they are not excluded from the assessment. The Holder failed to prove that the prior designs are based on the information from leaks in the Holder's group of companies and suppliers. The submitted documents do not establish that genuine images have been leaked, but rather that fans have imagined what future products may look like. This is not an 'abuse' within the meaning of Article 7(3), which is concerned with scenarios such as theft.
- (38) Regarding the quality of the reproductions, the Applicants hold that the established case-law does not require a prior design to be shown in all views. Inconsistently with the Holder's argumentation in its rejoinder, in related court proceedings the Holder insists that what matters is the front of the product, as this is how the device is seen by users and in certain positions of usage it is the only surface visible, such as when the user holds the tablet in their hands or uses it by placing it on a flat surface. According to the Applicants the prior designs can be assessed on the overall impression even if they are not shown in all views in which the RCD is registered, the prior designs are not precluded from assessment even if not shown as clearly as the RCD and it is not necessary to be able to deduce every feature of the prior design from the disclosure where such features are of little relevance to the overall impression. The evidence submitted by the Applicants is of sufficient quality. Where multiple designs are evidenced in some exhibits, each must be assessed individually.
- (39) The Applicants further maintain that the views of the RCD are contradictory and do not allow third parties to unambiguously determine what is claimed. The Holder should surrender the first view.
- (40) According to the case-law designers of functional elements retain freedom to create distinctive designs, which does not mean that these elements are not

dictated solely by their technical function. Many (if not all) elements of the RCD are solely dictated by the technical function, hence these elements do not qualify for protection under the CDR or at least they are partly dictated by technical function and they will have a limited impact on the informed user. Regarding the disputed features the Applicants hold that the prior designs are all relatively thin, the vast majority of the prior designs contain large screens, the overwhelming majority of the prior designs are rectangular and all the prior designs show rounded corners with only limited variation in the rounding.

- (41) The Applicants submit additional images of D18 to show that the design does not feature a raised surrounding chassis:

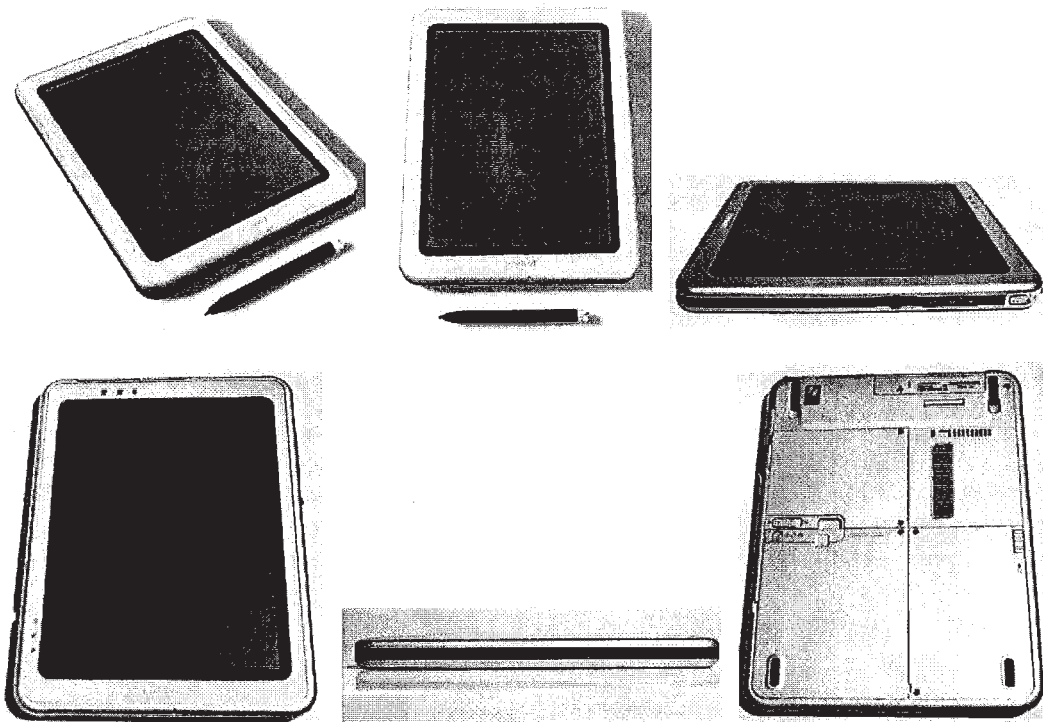

D18

- (42) D14 and D20 come from the time when touch screen technology required physical protection for the screen (the raised surround) as witnessed in the expert report submitted by the Applicants. By contrast, modern designs do not require a raised surround, and such a feature does not appear in the more recent prior designs. The elements named by the Holder being impacted by design constraints do not have great importance in the assessment of the overall impression of the RCD.

- (43) The Applicants submit additional evidence:

- screenshot of a video contained in a news article posted on the website <http://news.cnet.com> on 08/09/2008, entitled 'Plastic Logic's plastic reader is thin, simple, strong', containing images of the Plastic Logic E-Reader (hereinafter design D55, the Applicants' enclosure DAS-68), and
- printouts of news articles posted on the website <http://www.pcworld.com> on 07/01/2010, entitled 'Plastic Logic's Que E-Reader Revealed', and <http://portable-ebook-reader.net> on 12/02/2010, entitled 'Plastic Logic Que

Preview', containing images of Plastic Logic Que E-Reader (hereinafter design D56, the Applicants' enclosure DAS-69).

- (44) The Applicants point to D7, D6, D5, D36, D4, D13, D9, D43, D46 and D53 as the prior designs which clearly create the same overall impression. According to the Applicants verbal analysis is not required to support the prior designs.
- (45) In its rejoinder the Holder submits that Article 7 CDR does not require the Holder to positively show that the relevant circles actually had no knowledge, but it is sufficient to demonstrate that knowledge was not possible within the limits of what was reasonable. The facts and background information provided by the Holder about the nature, structure, distribution and popularity of the sources, as well as the number and variety of different sources in the field are sufficient. Blogs or websites similar to blogs as a source of disclosure are not systematically searchable and if all posts on all existing blogs had to be taken into account per se, this would lead to absurd results because it would be necessary to access and check an unmanageable quantity of blogs every day if not every hour. Obviously, this would not be part of the 'normal course of business'. The websites on which the prior designs in DAS-20 were disclosed are uncommon private blogs. Even the Applicants do not consider them as a source that could reasonably have become known to the relevant circles when in other disclosures they rely on 'high-profile industry websites and blogs that specialise in discussing new developments in the electronics and gadgets space'.
- (46) In relation to disclosure of the prior designs as an abuse towards the Holder, a disclosure which is subject of the exception according to Article 7(3) CDR is not only limited to a disclosure of the contested RCD itself but also to any following 'copies' or 'intended reproductions' disclosed by third parties if these acts result from prior acts of the designer or its successor in title. The relevant test in this regard is individual character in the sense of Article 6 CDR. Should the Office consider the prior design and the RCD to produce the same overall impression, Article 7(3), (2) would apply and the design would not to be taken into consideration for the purpose of applying Articles 5 and 6 CDR.
- (47) The evidence concerning design D56 (DAS-59) does not prove disclosure of the design prior to the date of priority.
- (48) Registered designs D24, D29 and D50 relate to a part of an electronic device, such as a display screen, thus they do not anticipate decisive components of the contested RCD.
- (49) Regarding the individual character, the Holder reiterates that as shown by the various design alternatives, none of the features have a limited impact on the degree of freedom of the designer nor are they of less importance in determining the overall impression of the RCD. Likewise, the informed user pays particular attention to the specific appearance of any functional element. As a result the asserted features are neither solely nor 'partly' dictated by technical function and none of the features can be disregarded. The individual character must be assessed by way of comparison of the RCD with each prior design rather than by way of comparison with the design corpus. It does not comply with the standard of the test of individual character to pick out individual features that can be found in the design corpus and, on this basis, deny individual character of the contested RCD.

- (50) An overall assessment of the design corpus may only be relevant with regards to the degree of freedom of the design in developing the design, but the Applicants did not name the concrete features they consider as being 'common' in the existing design corpus.
- (51) For further details to the facts, evidence and arguments submitted by the parties, reference is made to the documents on file.

II. GROUNDS OF THE DECISION

A. Admissibility

- (52) The indication of the grounds for invalidity in the Application is a statement of the grounds on which the Application is based within the meaning of Article 28(1)(b)(i) CDIR. Furthermore, the Application complies with Article 28(1)(b)(vi) CDIR, since the Application contains an indication of the facts, evidence and arguments submitted in support of those grounds. The other requirements of Article 28(1) CDIR are fulfilled as well. The Application is therefore admissible.

B. Substantiation

B.1 Not a design

- (53) A registered Community design shall be declared invalid if it does not correspond to the definition of 'design'. According to Article 3(a) CDR a 'design' means the appearance of the whole or a part of a product resulting from the features of, in particular, the lines, contours, colours, shape, texture and/or materials of the product itself and/or its ornamentation.
- (54) The RCD is represented by a set of 7 coloured photographs. The first three views show the design from the front, the rest show the back and back side portions of the design. The first view is the front view on the design showing a dark screen. The second and third views show the same screen from perspective and detailed views. It is evident from those two views that the dark screen reflects the light. The same can be said for the first view. The image used as the first view on the RCD produces the same effect as the image of the prior design D6a (see paragraph 5), which neither the Holder nor the Applicants disputed as unclear.
- (55) The Office does not find any inconsistency in the views on the design nor lack of clarity of the claim. The design is registered for the appearance of a portable display device resulting from its shape, and other visual features. The RCD meets the definition of the 'design' according to Article 3(a) CDR.

B.2 Convention Priority

- (56) An application for a Community design may claim the priority of one or more previous applications for the same design or utility model in or for any State party to the Paris Convention, or to the Agreement establishing the World Trade Organisation (Article 41 CDR; Article 8 CDIR). The right of priority is six months from the date of filing of the first application.

- (57) The effect of the right of priority shall be that the date of priority shall count as the date of filing of the application for a registered Community design for the purpose of Articles 5, 6, 7 and 22, Article 25(1)(d) and Article 50(1) CDR (Article 43 CDR).
- (58) A priority claim relating to the 'same design or utility model' requires identity with the corresponding Community design without addition or suppression of features (The Manual concerning the Examination of Designs Invalidity Applications, OHIM June 2012, Section C.5.1.8).
- (59) The Applicants claim that the subject matter of priority application No 29/382,846 and the RCD is not the same, the design patent in the priority application was granted for black and white drawings while the RCD is registered in coloured photographs, and that the set of images in the priority application corresponding to those in the Community design registration contain a logo, which is not applied on the RCD.
- (60) According to the Paris Convention for the Protection of Industrial Property, any filing that is equivalent to a regular national filing under the domestic legislation of any country of the Union shall be recognised as giving rise to the right of priority. By a regular national filing is meant any filing that is adequate to establish the date on which the application was filed in the country concerned, whatever may be the subsequent fate of the application (Article 4A(2) and (3)).
- (61) The priority application is a regular national filing for which the date of filing was established. It contains a set of coloured photographs which correspond to the views in the Community design registration. Therefore, the priority claim based on this set of photographs is claimed rightfully, regardless of the fact that in the process of granting the design patent these images were abandoned and not published.
- (62) The priority application also contains a verbal disclaimer regarding the logo, which is not claimed and serves only for illustrative purposes. While the filing office of the priority application does allow such a verbal disclaimer, the applicant for registering a Community design is allowed to limit the scope of protection only by a graphical disclaimer. Therefore, the Holder filing the Community design application can either show the logo in dotted lines or apply another graphical disclaimer, which in the case of photographs is considerably difficult, or omit the logo from the representations of the design. The scope of protection of the claimed design is the same in the priority application as it is in the registration of the Community design. In the absence of harmonised rules for claiming the priorities from and for different jurisdictions, which apply different formal requirements on representations of claimed designs, the Office considers the priority claim rightful and the date of priority of 06/01/2010 as effective.

B.3 Disclosure

- (63) According to Article 7(1) CDR, for the purpose of applying Articles 5 and 6, a design shall be deemed to have been made available to the public if it has been published following registration before the date of filing of the application for registration of the design or the date of priority, as the case may be, except where these events could not reasonably have become known in the normal course of business to the circles specialised in the sector concerned, operating within the Community.

- (64) According to Article 7(2) CDR, a disclosure shall not be taken into consideration for the purpose of applying Articles 5 and 6 if a design for which protection is claimed under a registered Community design has been made available to the public by the designer, his successor in title or a third person as a result of information provided or action taken by the designer or his successor in title during the 12-month period preceding the date of filing of the application or, if a priority is claimed, the date of priority.
- (65) According to Article 7(3) CDR, paragraph 2 shall also apply if the design has been made available to the public as a consequence of an abuse in relation to the designer or its successor in title.
- (66) Designs D51 and D54 were published after the date of priority of the contested RCD and thus do not form part of the prior art. Designs D52 and D53 are registered Community designs of the Holder, which were published within the grace period of 12 months before the date of priority. Therefore, they are excluded from the assessment of the novelty and individual character pursuant to Article 7(2) CDR.
- (67) At the later stage the Applicants submitted D55 and D56 as additional prior designs. The subject matter of the proceedings has to be defined in the Application. Additional earlier designs when submitted at the belated procedural stage of the reply, if the effect is to alter the subject matter of the proceedings, are inadmissible (see the Manual concerning the Examination of Design Invalidation Applications, OHIM June 2012, sections B.1.4.1, A.9.1 and A.9.2). For the said reason any disclosures, views or evidence concerning designs which have been submitted in the Application are found admissible. Designs D55 and D56 submitted for the first time in the reply to the Holder's rejoinder are found inadmissible.
- (68) The Applicants further claim 50 prior designs. D1, D2, D7, D8, D10, D11, D12, D16, D19, D22, D23, D24, D25, D27, D28, D29, D31, D32, D33, D35, D36, D37, D42, D43, D47, D48, D49 and D50 are registered designs at national offices, registered Community designs at the Office, granted patents and published patent applications. They have been disclosed by publication resulting from the administration acts at the respective offices. The Applicants submit as proof of these events extracts from databases of the offices providing online access to the information on the registers, and copies of registrations. The dates of publishing are stated by the respective administrative office and they are not disputed by the Holder. Where the submitted documents are not in the language of proceedings, the date of publishing is accorded by the INID code of WIPO standard for bibliographic data of patents and designs documents. The Office thus considers disclosures of these designs as being proved.
- (69) Designs D14, D15 and D20 were disclosed by publishing as witnessed by Roger Fidler. The disclosures of the designs are not disputed by the Holder. The designs deem to be made available to the public before the date of priority of the RCD.
- (70) Designs D3, D4, D5, D6, D9, D13, D17, D18, D21, D26, D30, D34, D38, D39, D40, D41, D44, D45 and D46 have been disclosed on the internet. As a matter of principle, disclosures derived from the internet form part of the prior art. Information disclosed on the internet is considered to be publicly available as of the date the information was posted.

- (71) The evidence concerning design D3 consists of two internet disclosures: a print out of a webpage in Korean containing images of LG Flatron Tablet L 1530TM and three dates 2004-04-17, 2003-07-01 and 2011-10-18. The Applicants did not submit the translation of the document and from the document itself it is not clear what the dates mean. None of the dates clearly indicates the date of posting the information on the internet. The date of printing of the webpage is 17/10/2011, which is not before the date of priority of the RCD. For the above said reasons the evidence of the disclosure of the design LG Flatron Tablet L 1530TM in this piece of evidence is insufficient.
- (72) The Applicants further submit a webpage with a news article in German containing an image of Flatron Tablet in one view. The news article contains the publishing date of the article on the website as being 25/03/2003, thus the date of disclosure is accorded. The image of Flatron Tablet, however, is not of the quality to disclose all the essential features of the design. It may prove the disclosure of the prior design in the other submitted documents, the Korean website and three detail images of Flatron Tablet L 1530TM, however, neither the image, nor the text in the German document, contains the indication of Flatron Tablet L 1530TM. As Flatron Tablet can be offered in different models and the only image provided is not good enough to identify the model L 1530TM as shown in the other images, the disclosure of design D3 is insufficient and design D3 has to be disregarded.
- (73) The news article containing design D4 was posted on the internet on 06/01/2010, which is not before the date of priority of the contested RCD. David Stone in his witness statement submits that the design was disclosed at the Consumer Electronics Show (CES) in 2010, but neither the evidence on file nor the news article itself show the date of the event. The news article says that the HP slate tablet was 'just' shown off. Considering the fact that the article was posted on the internet at 10:40 pm and the fact that providing news on internet blogs and news websites is very fast, the act of disclosure of the HP tablet might have happened on the same day. In the absence of any evidence proving earlier disclosure, design D4 is not considered being disclosed before the date of priority of the RCD and is disregarded.
- (74) The news article containing design D9 was posted on the internet on 08/01/2010, which is not before the date of priority of the contested RCD. David Stone in his witness statement submits that the design was disclosed at the Consumer Electronics Show (CES) in 2010 but neither the evidence on file nor the news article itself show the date of the event or further details of the disclosure. Design D9 is thus not considered being disclosed before the date of priority of the RCD and is disregarded.
- (75) Neither restricting access to a limited circle of people (e.g. by password protection), nor requiring payment for access (analogous to purchasing a book or subscribing to a journal) prevent a web page from forming part of the state of the art. It is sufficient if the web page is available without any bar of confidentiality and the accessibility requirements can reasonably be met by the European professionals of the circles concerned.
- (76) The Holder claims that the internet disclosures do not meet the second condition as events which could not reasonably have become known in the normal course of business to the circles specialised in the sector concerned, operating within the Community because the websites on which the prior designs were disclosed are

blogs and blog-like websites publishing contributions according to the interest of their private holder. Such contributions cannot be systematically searched and thus they remain unknown to the Community circles specialised in the sector concerned.

- (77) In disclosure concerning designs D17 the article contains a range of pictures of 'mock-ups' of Apple products and references to the sources of information and previous publishing of the information and images. Hence the disclosure of the prior designs was not a single act on the private blog. On the contrary, the disclosure of prior designs did not remain unspotted on the internet and the information spread by publishing on different websites.
- (78) The disclosures are not unsearchable either. To search on the internet, users, either the broad public or experts in a particular field of industry, usually use the service of web browsers like Google or Yahoo. By applying key words, users can obtain results of websites dealing with the given subject matter. Therefore, the information on the internet is not irretrievable as the Holder suggests.
- (79) The internet is a permanently changing environment. The webpages are updated mostly without archiving previous contents. Therefore, the information contained on it appears and disappears over time. However, the prior designs have been on the internet, they have been accessible and retrievable by the Applicants, the Holder and other users, which can include the European professional in the field of communication and information retrieval equipment covering tablets and other portable display devices. In the proceedings before the Office, both the Applicants and the Holder kept delivering further images of the submitted prior designs, thus proving their accessibility on the internet. The disclosures are not obscure in the sense in which the limitation of the absolute novelty in Article 7(1) CDR was intended according to the *travaux préparatoires*. It is not the situation when a design disappears from the mankind's memory over time and is available only in a local museum or traded on a remote local market. An obscure design on the internet would have to be irretrievable or hardly retrievable by regular browsers, which is not the case of the prior designs. Therefore, the exception according to Article 7(1) CDR does not apply.
- (80) The Holder further claims that the disclosures in DAS-20 of designs referred to as prior designs D17 and showing various 'mock-up' and 'prototypes' of the Holder's products should not be taken into consideration due to the abuse of the information in relation to the Holder pursuant to Article 7(3) CDR. However, the Holder is not the designer or the successor in title of the designs, nor does it claim that a particular design or some particular information was copied or stolen. In the absence of any further evidence, the claim has to be rejected too.
- (81) The Holder further claims that disclosure DAS-8 concerning design D6 and DAS-20 concerning design D17 do not contain one but several designs. The Office agrees with the Holder and all the disclosed product alternatives are assessed individually.
- (82) The fact that the disclosed products were never produced or commercialised is irrelevant for the assessment of novelty and/or individual character. For the purpose of the tests it is enough if the prior designs are disclosed and the disclosure allows the qualified assessment of the designs' features.
- (83) The contested RCD is registered for the design of a portable display device resulting from the following features, which have to be as the minimum taken into

consideration when compared with the prior designs: a screen over the front side, considerably thin profile, a casing which rims the screen in a narrow line, forms slim vertical sides and turns in a sharp edge back in a conical shape raises toward the centre. The back of the device does not contain any elements, thus what matters is the conical shape of the casing. Where these features are not discernible from the representation of a prior design, the design fails to be adequately represented and any comparison with the contested design is impossible, which does not amount to disclosure for the purpose of Article 7(1) CDR (decision of 10/03/2008, 'Bargecues', R 586/2007, paragraphs 22 et seq.).

- (84) As it has already been said in paragraph 72, prior design D3 is disclosed in a single view and in a size and quality which do not allow the essential features of the design to be assessed. For this reason D3 is disregarded.
- (85) Prior design D5 is disclosed in front and side views. The side view is not clear enough to allow the essential features of the design to be assessed, and the representations of the design do not allow assess the back of the design. Consequently, design D5 is disregarded.
- (86) Where the designs are disclosed in a front or perspective view, and a side view allows the shape or contours of the back part of the product to be determined, or there is a back view, such disclosures are considered sufficient to make the assessment of novelty and individual character. However, the following designs cannot be assessed due to the insufficient disclosure: three variants referred as design D6, two views in disclosures concerning D13 dissimilar to the views on D13 as shown in paragraph 5, eleven designs of 'mock-ups' recognised in DAS-20 and referred as designs D17, and designs D21, D24, D26, D27, D30, D31, D34, D39, D40, D45 and D48. These designs are not taken into consideration for the tests of novelty and individual character.

B.4 Technical Function

- (87) According to Article 8(1) CDR a Community design shall not subsist in features of appearance of a product which are solely dictated by its technical function.
- (88) In compliance with the Manual of the Office concerning the examination of design invalidity applications Article 8(1) CDR must be interpreted as meaning that the 'CDR denies protection to those features of a product's appearance that were chosen exclusively for the purpose of designing a product that performs its function, as opposed to features that were chosen, at least to some degree, for the purpose of enhancing the product's visual appearance' (decision of 22/10/2009, R 690/2007-3, 'Chaff cutters', paragraphs 30 et seq.).
- (89) Furthermore, in compliance with the Manual, in order to determine features solely dictated by technical function it is necessary to determine what the technical function of that product is. The relevant indication in the application for registration of that design (Article 36(2) CDR) should be taken into account and also, where necessary, the design itself, in so far as it makes clear the nature of the product, its intended purpose or its function (see, by analogy, judgment of 18/03/2010, T/9/07, 'Representation of a circular promotional item', ECR II-981, paragraph 56).'
- (90) The indication of products of the RCD is a 'portable display device'. The representations of the RCD show a considerably flat electronic device having a

screen and casing apparently allowing it to be carried or held. The technical function of the product in which the RCD is incorporated is to display information and to allow the user to be mobile, regardless of the place of use. In order to be portable, therefore, the device cannot be excessively large or robust, although it does not necessarily need to be as thin as possible, as suggested by the Applicants. It is supposed to display information or internet content, thus it requires a screen and elements to trigger and operate the functions of the device. The device requires at least an on/off button and it can be equipped with other functionalities and elements like camera, loudspeakers, slots etc. The configuration of the device, the choice, making and placement of the elements, however, is a matter of the designer's will. The Office agrees with the Holder that the features of the material like durability are not part of the claim resulting from the registration of the contested Community design, and that weight, as it is not a visual feature, is beyond the scope of the assessment.

- (91) The Manual states that 'Whether Article 8(1) CDR applies must be assessed objectively, not in the perception of the informed user, who may have limited knowledge of technical matters.' Accordingly the Board of Appeal held in decision of 29/04/2010, R 0211/2008-3, 'Fluid distribution equipment', paragraph 35: 'These matters must be assessed objectively: it is not necessary to determine what actually went on in the designer's mind when the design was being developed. The matter must be assessed from the standpoint of a reasonable observer who looks at the design and asks himself whether anything other than purely functional considerations could have been relevant when a specific feature was chosen.'
- (92) The market of portable electronic devices is highly competitive, targeting young people. For both reasons, the products in this field compete not only in terms of their technical but also their design features. The nature of the product speaks in favour of strong design considerations forced by market requirements. The design of the product plays a significant role in marketing this kind of product. All the components of the products are tuned to the final overall look. The particular shape, proportions of the product and its components, and their configuration are carefully considered. The Office did not find anything on file to indicate that the product in which the RCD is incorporated or any of its parts or elements were developed under purely functional considerations.
- (93) For the reasons given above none of the features appointed by the Applicants (flat display, slim profile, shape, rounded corners, functional elements or camera) are considered being solely dictated by the technical function pursuant to Article 8(1) CDR.

B.5 Novelty

- (94) According to Article 5 CDR, the RCD lacks novelty when an identical design has been made available to the public prior to the date of filing of the RCD or the date of priority. Designs shall be deemed to be identical if their features differ only in immaterial details.
- (95) According to the Holder the Applicants do not raise the ground of novelty, nevertheless, the Applicants claim in relation to prior designs D1, D2, D7, D16 and D17a that these designs are identical with the RCD under Article 5(2) CDR. The Office considers such a claim sufficient to assess the RCD on novelty for all the submitted prior designs.

(96) Taking into account the submissions of the parties, the Office finds the following essential features in the contested RCD:

- the device is composed of a flat screen and a casing,
- it is substantially rectangular with evenly rounded corners,
- it has a front screen rimmed by the narrow line of the casing,
- the screen is divided in two fields, a rectangular inner field, which is surrounded by a frame,
- there is a home button on the bottom short side of the frame area,
- the casing forms narrow side walls vertical to the screen, and sharp edges with the back of the device,
- in plan and side views the back has the effect of a four-sided very obtuse cone,
- the casing is gently recessed at the point where it touches the screen,
- the casing is light in colour, which contrasts with the dark screen,
- on three of the narrow vertical sides there are functional elements like sockets and slots.

(97) Prior design D1 is incorporated in a 'bezel-less Electronic display'. The same design is disclosed as D2, D11 and D12, which claim the priority from filing of D1, and designs D8 and D10 relate to the same invention and differ from D1 only immaterially; therefore, all the designs are considered together. The Holder's claim that design D2 was disclosed in the German registration only in one view and only this single view should be taken into consideration is not founded as the design was disclosed in the priority application in all views. The prior designs D1, D2, D8, D10, D11 and D12 differ from the RCD in the following features:

- the side walls are wider than in the RCD and they are not vertical but bevelled in an acute inner angle with the screen,
- the casing is flat on the back and it has a rectangular opening in the middle,
- there are no functional elements in the sides and no home button on the front,
- the prior designs are disclosed in no particular colour combination.

The differences in the shape of the casing, the absence of colours and functional elements recognised in the RCD and the prior designs are not immaterial details, hence designs D1, D2, D8, D10, D11 and D12 do not constitute an obstacle to the novelty of the RCD.

(98) Prior design D6a (red) is incorporated in a portable display device. It differs from the RCD in the following features:

- the casing of the device surrounds the screen with a wider frame on the short sides and a narrower frame on the long sides,
- the casing curves from the top to the sides and back so it does not form any substantially flat side walls,
- on the back the casing is bevelled towards the centre but the back is substantially flat,
- there is no home button and there are no functional elements built in the device,
- the casing is red in contrast to the black screen.

The differences in the shape of the casing, the frame of the screen, the colour combination and the absence of functional elements recognised in the RCD and

the prior design are not immaterial details, hence design D6a (red) does not constitute an obstacle to the novelty of the RCD.

(99) Prior design D6b is incorporated in a portable display device. The Holder submitted some detail views in the course of the proceedings (see paragraph 27). The images show prior design D6b and the evidence is taken into account. The prior design differs from the RCD in the following features:

- the casing forms very narrow side walls with the screen and is bevelled towards the centre of the back; the casing does not rim the screen,
- the back is substantially flat,
- there is a perforation and a rectangular opening in the back and there are some functional elements built in the bevelled sides; the elements and their configuration in the device differ from the RCD,
- the black casing matches the colour of the black screen.

The recognised differences in the shape of the casing, the colour combinations and the functional elements between the RCD and the prior design are not immaterial details, hence design D6b does not constitute an obstacle to the novelty of the RCD.

(100) Prior design D7 is incorporated in a handheld computer. It differs from the RCD in the following features:

- the vertical sides of the casing curve in the substantially flat back,
- there is no home button on the screen,
- the prior design is disclosed in no particular colour combination.

The differences in the shape of the casing and the absence of colours and functional elements recognised in the RCD and the prior design are not immaterial details, hence design D7 does not constitute an obstacle to the novelty of the RCD.

(101) Prior design D13 is incorporated in a tablet. It differs from the RCD in the following features:

- the screen is framed with a rim which is not recessed like in the RCD but raised above the screen,
- there is a distinctive red home button at the bottom long side of the screen and other buttons at the top long side of the screen,
- the vertical sides of the casing curve in the substantially flat back,
- there is a large round element and some perforations in the back,
- the black casing matches the colour of the black frame area of the screen.

The recognised differences in the shape of the casing, colour combinations and the configuration of the functional elements between the RCD and the prior design are not immaterial details, hence design D13 does not constitute an obstacle to the novelty of the RCD.

(102) Prior design D14 is incorporated in a tablet. It differs from the RCD in the following features:

- the screen and its frame have considerably sharp picture-frame-like corners,
- the narrow vertical sides form sharp edges with the screen and flat back,

- there are no functional elements,
- the casing is light in colour; there is no contrasting colour combination.

The recognised differences in the shape of the casing, the colour combinations and the absence of functional elements between the RCD and the prior design are not immaterial details, hence design D14 does not constitute an obstacle to the novelty of the RCD.

(103) Prior design D15 is incorporated in a tablet. It differs from the RCD in the following features:

- the screen is framed in a massive rim of the casing which is raised above the screen,
- the vertical narrow sides curve in the flat back,
- the back has a large opening and its cover spreads almost all over the back,
- there are no functional elements in the front, back or sides,
- the casing is black, there is no contrasting colour combination with the screen.

The recognised differences in the shape of the casing, the colour combinations and the absence of functional elements between the RCD and the prior design are not immaterial details, hence design D15a does not constitute an obstacle to the novelty of the RCD.

(104) Prior design D16 is incorporated in an electronic book. It differs from the RCD in the following features:

- the screen is divided into three zones, the rectangular inner display, a frame and a separate bottom part, which contains a home button in the middle,
- there is a slot on the short top side of the frame,
- the bevelled narrow sides curve towards the considerably flat back,
- there are some sockets or slots in the side walls but in different configuration than in the RCD,
- the prior design is disclosed in no particular colour combination.

The recognised differences in the shape of the casing, the configuration of the functional elements and the absence of colours between the RCD and the prior design are not immaterial details, hence design D16 does not constitute an obstacle to the novelty of the RCD.

(105) Prior design D17a is incorporated in a tablet. It differs from the RCD in the following features:

- the sides of the casing curve in the substantially flat back,
- there is a home button in the shape of the Apple logo on the screen,
- there are no functional elements.

The differences in the shape of the casing and in the absence of functional elements recognised in the RCD and the prior design are not immaterial details, hence design D17a does not constitute an obstacle to the novelty of the RCD.

(106) Prior design D17b is incorporated in a tablet. It differs from the RCD in the following features:

- the sides of casing form sharp edges with the front and the flat back,
- the display spreads towards the long sides of the screen, thus there is no continuous black frame all around the screen, only two black areas at the short sides of the screen.

The recognised differences in the shape of the casing and the screen configuration between the RCD and the prior design are not immaterial details, hence design D17b does not constitute an obstacle to the novelty of the RCD.

(107) Prior design D17c is incorporated in a tablet. It differs from the RCD in the following features:

- the sides of the casing curve from the front to the flat back with no sharp edges,
- the screen is divided into a considerably large display and a narrow black frame,
- the sides contain a number of slots, sockets and other functional elements in a different configuration to that in the RCD,
- the flat back has four elements in the corner and a dividing line at the bottom.

The recognised differences in the shape of the casing, the screen and the functional elements between the RCD and the prior design are not immaterial details, hence design D17c does not constitute an obstacle to the novelty of the RCD.

(108) Prior design D17d is incorporated in a tablet. It differs from the RCD in the following features:

- the bevelled sides of casing curve in the substantially flat back,
- the screen is divided into a considerably large display and a narrow black frame,
- there are no functional elements on the sides.

The differences in the shape of the casing, in the screen and the absence of functional elements recognised in the RCD and the prior design are not immaterial details, hence the design D17d does not constitute an obstacle to the novelty of the RCD.

(109) Prior design D17e is incorporated in a tablet. It differs from the RCD in the following features:

- the sides of casing form sharp edges with the front and with the flat back,
- the screen is divided into a considerably large display and a narrow black frame,
- there are no functional elements on the sides.

The differences in the shape of the casing, in the screen and the absence of functional elements recognised in the RCD and the prior design are not immaterial details, hence design D17e does not constitute an obstacle to the novelty of the RCD.

(110) Prior design D17f is incorporated in a tablet. It differs from the RCD in the following features:

- the screen is framed in a casing which seems to rise above the screen and turns around smoothly towards the substantially flat back,
- there are some functional elements indicated in the front and sides, but in a different configuration than in the RCD,
- the prior design is disclosed in no particular colour combination.

The differences in the shape of the casing, in the functional elements and the absence of colours recognised in the RCD and the prior design are not immaterial details, hence design D17f does not constitute an obstacle to the novelty of the RCD.

(111) Prior design D18 is incorporated in a tablet with a keyboard. In the course of proceedings the Applicants submitted detailed images of the same tablet without keyboard (see paragraph 41) and they are accepted too. The design is assessed on relevant parts, i.e. without keyboard. The prior design differs from the RCD in the following features:

- the screen is framed in a silver and black casing which has gentle protrusions in the front,
- the sides of the casing curve from the front to the flat back with no sharp edges, they are combined in black and silver colours and equipped with a range of built-in buttons and functional elements,
- the substantially flat back is divided into four fields with a range of elements like perforations, buttons, a stand support and openings.

The recognised differences in the shape of the casing, the screen, the configuration of the functional elements and the colour combination between the RCD and the prior design are not immaterial details, hence prior design D18 does not constitute an obstacle to the novelty of the RCD.

(112) Prior design D19 is incorporated in a 'television apparatus'. The design subsists of a simple rectangle with vertical, substantially narrow sides, a flat front and flat back. The RCD differs in all recognised features – the shape, contours, presence of functional elements and the colour combination. The differences are not immaterial details, hence design D19 does not constitute an obstacle to the novelty of the RCD.

(113) Prior design D20 is identical to D15. Hence the conclusions of paragraph 103 are valid also for design D20.

(114) Prior design D22 is incorporated in a memory card for an electronic pocket notebook. The design consists of the shape of a simple slim rectangle with rounded corners curving from the flat front to the flat back. The RCD differs in all recognised features – the shape, contours, presence of functional elements and the colour combination. The differences are not immaterial details, hence design D22 does not constitute an obstacle to the novelty of the RCD.

(115) Prior design D23 is incorporated in a radio transceiver housing. It is flat on the front with a robust casing bevelled towards the substantially flat back. The design has the shape of a robust picture frame (seen from the back). The RCD differs in all recognised features – the shape, contours, presence of functional elements and the colour combination. The differences are not immaterial details, hence design D23 does not constitute an obstacle to the novelty of the RCD.

(116) Prior design D25 is incorporated in a protection device for monitors. The design subsists in the shape of a frame and transparent screen. There is no casing. The RCD differs in all recognised features – the shape, contours, presence of functional elements and the colour combination. The differences are not immaterial details, hence design D23 does not constitute an obstacle to the novelty of the RCD.

(117) Prior design D28 differs from the RCD in the following features:

- the screen is framed in a casing which on one short side is wider than on the other three sides,
- there are some functional elements indicated on the front and sides,
- the prior design is flat,
- the prior design is disclosed in no particular colour combination.

The differences in the shape of the casing, the functional elements and the absence of a colour combination recognised in the RCD and the prior design are not immaterial details, hence design D28 does not constitute an obstacle to the novelty of the RCD.

(118) Prior design D29 is incorporated in a data display unit. It differs from the RCD in the following features:

- the screen is more square than rectangular,
- the sides are bevelled toward the substantially flat back,
- there are no functional elements,
- the prior design is disclosed in no particular colour combination.

The differences in the shape and the absence of colour combinations and functional elements recognised in the RCD and the prior design are not immaterial details, hence design D29 does not constitute an obstacle to the novelty of the RCD.

(119) Prior design D32 is incorporated in a device which is substantially rectangular with a considerably robust frame in the front and rounded sides. There are two buttons on the front. The RCD differs in all features – the shape, contours, the configuration of the functional elements and the colour combination. The recognised differences are not immaterial details, hence design D32 does not constitute an obstacle to the novelty of the RCD.

(120) Prior design D33 is incorporated in a device which is more square than rectangular and which is flat in front and back. It has a support in the back to hold the device upright. The RCD differs in all features – the shape, contours, presence of functional elements on the sides and the colour combination. The recognised differences are not immaterial details, hence design D33 does not constitute an obstacle to the novelty of the RCD.

(121) Prior design D35 differs from the RCD in the following features:

- the screen has a frame which has a perforation around its short sides,
- the casing forms narrow sides bevelled from the screen towards the back,
- the sides curve towards the substantially flat back,
- there are some functional elements on the sides and back of the device but in a different configuration from the RCD,
- the prior design is disclosed in no particular colour combination.

The differences in the shape of the casing, the configuration of the functional elements and the absence of a colour combination recognised in the RCD and the prior design are not immaterial details, hence design D35 does not constitute an obstacle to the novelty of the RCD.

(122) Prior design D36 differs from the RCD in the following features:

- the screen has no frame but the casing lines the front in a narrow surrounding,
- the design is flat in the back,
- the vertical sides form sharp edges with the front and back,
- there are some functional elements on the sides, but in a different configuration from the RCD,
- the prior design is disclosed in no particular colour combination.

The differences in the shape of the casing, in the configuration of the functional elements and the absence of a colour combination recognised in the RCD and the prior design are not immaterial details, hence design D36 does not constitute an obstacle to the novelty of the RCD.

(123) Prior design D37 is incorporated in a tablet. It differs from the RCD in the following features:

- the screen is more square than rectangular,
- the design has no substantial sides and the back is flat,
- there is a raised round frame around the screen with an indented area,
- there are no functional elements,
- the prior design is disclosed in no particular colour combination.

The differences in the shape of the casing, the absence of functional elements and the colour combination recognised in the RCD and the prior design are not immaterial details, hence design D37 does not constitute an obstacle to the novelty of the RCD.

(124) Prior design D38 is incorporated in a tablet. It differs from the RCD in the following features:

- the screen is framed by a casing which curves on the short sides towards the flat back,
- the transition of the casing on the long sides is sharp with edges in the front and back,
- the casing contains a range of functional elements on the vertical and rounded sides, but in a different configuration from the RCD.

The recognised differences in the shape of the casing and in the functional elements between the RCD and the prior design are not immaterial details, hence design D38 does not constitute an obstacle to the novelty of the RCD.

(125) Prior design D41 is incorporated in a portable computer. It differs from the RCD in the following features:

- the screen is framed by a casing which turns in sharp edges towards the vertical sides and the flat back.

- the casing rim around the screen is robust in comparison to the narrow line in the RCD,
- the casing contains a range of functional elements on vertical sides, however in a different configuration from the RCD,
- the home button is located on the casing in the front right bottom corner,
- the design resembles a book or a thicker picture frame.

The recognised differences in the shape of casing, and in functional elements between the RCD and the prior design are not immaterial details, hence design D41 does not constitute an obstacle to the novelty of the RCD.

(126) Prior design D42 is incorporated in a tablet. It differs from the RCD in the following features:

- the screen is rectangular with a considerably angular front,
- the casing is flat on the back,
- the frame area at the short bottom side on the front is wider than other sides and there is a home button embedded in its border,
- the back contains several elements, including a support for holding the tablet in a vertical position,
- there is only one round plug on the side wall,
- the prior design is disclosed in no particular colour combination.

The differences in the shape of casing, in the functional elements and the absence of a colour combination recognised in the RCD and the prior design are not immaterial details, hence design D42 does not constitute an obstacle to the novelty of the RCD.

(127) Prior design D43 is incorporated in a tablet. The Holder claims that the prior design should not be taken into consideration because it is registered for a screen and not for a tablet as such. Nevertheless, what is disclosed is the tablet and the disclaimed features in the prior design form part of the state of art (see Manual concerning the Examination of Design Invalidity Applications, OHIM June 2012, section C.5.2.1 Disclaimed Features). The prior design differs from the RCD in the following features:

- the casing curves from the vertical sides to the flat back,
- the frame area on the short sides at the front is wider than on the long sides at the front,
- there are some functional elements on the vertical sides but in different a configuration from the RCD,
- the prior design is disclosed in no particular colour combination.

The differences in the shape of the casing, the functional elements and the absence of a colour combination recognised in the RCD and the prior design are not immaterial details, hence design D43 does not constitute an obstacle to the novelty of the RCD.

(128) Prior design D44 is incorporated in a digital picture frame. The Applicants submit a single front view on the design but the Holder delivered a back and a side views (see paragraph 27). The frame is the product of the Applicants and they did not dispute the added views. Hence the design is deemed to be disclosed in the three views. It differs from the RCD in the following features:

- the casing frames the screen in front in a similar way to the casing in RCD but it turns back with an indented portion on the short sides and the bottom long side, and only after that it rises towards the centre,
- there are almost no side walls,
- the back contains several functional elements and a round feature in the middle to fix a support for the frame.

The differences in the shape of the casing and the functional elements in the RCD and the prior design are not immaterial details, hence design D44 does not constitute an obstacle to the novelty of the RCD.

(129) Prior design D46 is incorporated in a portable computer. It differs from the RCD in the following features:

- the casing frames the screen in front in a similar way to the casing in the RCD, it turns to the vertical sides with a sharp edge and again to the back, which is however flat,
- the vertical sides contain a range of functional elements but in a different configuration from the RCD,
- the back has several indented compartments.

The differences in the shape of the casing and the functional elements recognised in the RCD and the prior design are not immaterial details, hence design D46 does not constitute an obstacle to the novelty of the RCD.

(130) Prior design D47 is incorporated in a portable terminal. It differs from the RCD in the following features:

- the frame in the front is wider on its right short side and bottom long side,
- the casing curves from the front to the back,
- the substantially flat back and front contain several elements, while there are no functional elements on the sides,
- the prior design is disclosed in no particular colour combination.

The differences in the shape of the casing, the functional elements and the absence of a colour combination recognised in the RCD and the prior design are not immaterial details, hence design D47 does not constitute an obstacle to the novelty of the RCD.

(131) Prior design D49 is incorporated in a display. It differs from the RCD in the following features:

- the screen is framed by a casing which rises above the screen and forms an inner and outer frame,
- the outer frame area is wider on the bottom short side,
- the casing curves from the front to the back on the left long side while on the other sides the casing forms sharp edges with the front and back,
- the back is flat,
- the sides contain several functional elements in a different configuration from the RCD,
- the prior design is disclosed in no particular colour combination, though the darker screen and lighter casing can be discerned from the registration.

The differences in the shape of the casing, the functional elements and the absence of a colour combination recognised in the RCD and the prior design are

not immaterial details, hence design D49 does not constitute an obstacle to the novelty of the RCD.

(132) Prior design D50 is incorporated in an interactive board. It differs from the RCD in the following features:

- the screen is framed by a raised casing, which turns in flat back,
- there are no vertical sides,
- the sides contain several mechanical elements which do not appear in the RCD,
- the prior design has black frame and blue screen.

The differences in the shape of products, the colour combinations and the functional elements recognised in the RCD and the prior design are not immaterial details, hence design D50 does not constitute an obstacle to the novelty of the RCD.

B.6 Individual Character

(133) According to Article 6 CDR, the RCD lacks individual character if the overall impression produced on the informed user is the same as the overall impression produced on such a user by any design which has been made available to the public before the date of filing of the RCD or the date of the priority claimed. In assessing the individual character of the RCD, the degree of freedom of the designer in developing the design shall be taken into consideration.

(134) The informed user is, according to the established case-law, a particular observant who is aware of the state of the art in the sector concerned and uses the product related to the RCD in accordance with the purpose for which the product is intended (see judgment of 09/09/2011, T-10/08, 'Internal combustion engine', paragraphs 23 to 25).

(135) In the present case the informed user is familiar with designs of portable display devices. S/he is aware of the designs of products which were available before the date of priority of the contested RCD and s/he is aware of constraints to the designer's freedom given by technical requirements and the function of the device.

(136) The device has to be portable, it requires a screen to display information and some functional elements to be operated. Portable display devices can significantly differ in size, ranging from the size of mobile phones to the size of laptops, and they can differ in the ratio of the sides. The screen of the device is expected to have a display and to be rectangular, though, the division of the screen or application of some borders around the screen is not dictated by severe constraints. Market tendencies, aesthetic or commercial considerations, as argued by the Applicants in connection with flat screens, are not regarded as restrictions to the freedom of the designer (see judgment of 22/06/2010, T-153/08, 'Communication unit', paragraph 58).

(137) The portable device is supposed to be easily handled, carried, held, placed in bags and easily transported, etc. The user uses the device as such, not only its screen when placed on a flat surface. Therefore, the informed user as a particular observant takes into consideration not only the front part of the device, though it is the part of the product which allows it to function. When making a qualified

choice to purchase the product or not, the informed user also considers the casing and the overall shape, and s/he is able to differentiate between different products on the market. What matters is not only the functional part of the device, but also the shape and design of its body. The informed user is particularly attentive also due to the saturation of the market in the given field, which was considerably high before the date of priority of the RCD, as follows from numerous examples of submitted prior art by the Applicants. The density in the given field makes the informed user more sensitive to the differences between the products of the same or similar function (see judgment of 13/11/2012, T-83/11, Radiators for heating', paragraph 81). The user is attentive to even small differences between the designs.

- (138) As has been said before, the essential features of the RCD are the considerably slim profile, flat screen extended through the whole front of the device with borders and home button, the line of the casing forming a slim rim around the screen, the slim sides and the sharp edge turning into the conical back, and contrasting black screen embedded in the light coloured casing. Though these features, individually, may be part of the design corpus, in their combination the contested RCD differs from the submitted examples of the prior art.
- (139) The RCD is registered for the particular shape and colour combination of the portable display device. Comparing the prior and the contested designs, there are designs having a flat screen rimmed with a narrow light-coloured casing contrasting with a dark frame surrounding the display: these are designs D7, D17a, D17c, D17d, D17e, D44 and D46, but each of the designs differs in the shape of the casing which makes the overall impression of these designs different from the impression produced by the slim profile and conical back of the contested RCD. Design D17b produces a different overall impression due to the different configuration of the screen and the shape of the casing.
- (140) Designs D1, D2, D6b, D8, D10, D11, D12, D13, D16, D29, D35, D36, D42 and D43 depart from the contested RCD even further due to the colour combination which is either not disclosed or different. Design D33 produces a different overall impression due to the square shape of the screen, the considerably thick profile and the flat back.
- (141) The designs D6a (red), D14, D15, D17f, D18, D28, D32, D37, D38, D41, D47 and D49 have the screen surrounded by the frame of the casing. With different shapes of the casing at the back and sides, they produce a different overall impression from the impression produced by the RCD.
- (142) Design D19 is a simple block lacking all the distinctive features of the RCD. Design D22 produces the completely different impression of a slim card and not a display device. Design D23 produces an impression of a robust picture frame. The overall impression produced by these designs differs from the overall impression produced on the informed user by the contested RCD.
- (143) Designs D25 and D50 have an impression of a screen in a frame rather than a screen embedded in a casing. The overall impression is different. With their shape, designs D41 and D49 resemble a book and design D14 resembles a picture embedded in a simple angular frame. The impression produced by these designs departs far from the impression of smooth contours produced by the RCD.
- (144) The contested RCD has individual character over the submitted prior designs.

C. Conclusion

(145) The grounds of invalidity pursuant to Article 25(1)(a) and Article 25(1)(b) are unfounded.

III. COSTS

(146) Pursuant to Article 70(1) CDR and Article 79(1) CDIR, the Applicants shall bear the costs of the Holder.

(147) The costs to be reimbursed by the Applicants to the Holder are fixed to the amount of EUR 400 for the costs of representation.

IV. RIGHT TO APPEAL

(148) An appeal shall lie from the present decision. Notice of appeal must be filed at the Office within two months after the date of notification of that decision. The notice is deemed to have been filed only when the fee for appeal has been paid. Within four months after the date of notification of the decision, a written statement setting out the grounds of appeal must be filed (Article 57 CDR).

THE INVALIDITY DIVISION

Ludmila Čelišová

Jakub Pinkowski

Martin Schlötelburg

