



OPERATIONS DEPARTMENT

I406B

Alicante, 15/09/2017

Visser Schaap & Kreijger  
Willemsparkweg 150  
NL-1071 HS AMSTERDAM  
PAÍSES BAJOS

**Notification to the holder of a decision***Your reference:**Invalidity number:**Contested Community design:**Language of proceedings:**Name of the applicant:**Fax number:***ICD 10331****002621904-0001****English****Hirams Trade GmbH****00 31-207238985**

Please see the attached decision which ends the abovementioned invalidity proceedings. It was taken on **14/09/2017**.

**Katarina ČAVOR**

Enclosures (excluding the cover letter): 17 pages.

By fax: 00 31-207238985 &amp; register mail

**INVALIDITY No ICD 10 331**

**Hirams Trade GmbH**, Münchowstr. 1, 14129 Berlin, Germany (applicant), represented by **SKW Schwarz Rechtsanwälte**, Kurfürstendamm 21, Neues Kranzler Eck, 10719 Berlin, Germany (professional representative)

against

**Fatboy the Original B.V.**, De Steenbok 19-21, 5215 MG 's-Hertogenbosch, The Netherlands (applicant), represented by **Visser Schaap & Kreijger**, Willemsparkweg 150, 1071 HS Amsterdam, The Netherlands (professional representative).

On 14/09/2017, the Invalidity Division takes the following

**DECISION**

1. The application for a declaration of invalidity of registered Community design No 002621904-0001 is rejected.
2. The applicant bears the holder's costs, fixed at EUR 400.

**REASONS**

The applicant filed an application for a declaration of invalidity (the application) against Community design No 002621904-0001 (the RCD). The RCD was filed and registered on 28/01/2015 and later transferred into the holder's name.

The following products are indicated in the registration:

**06-01** *Chaise longues.*

The registration contains the following images:

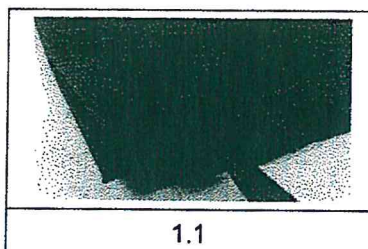

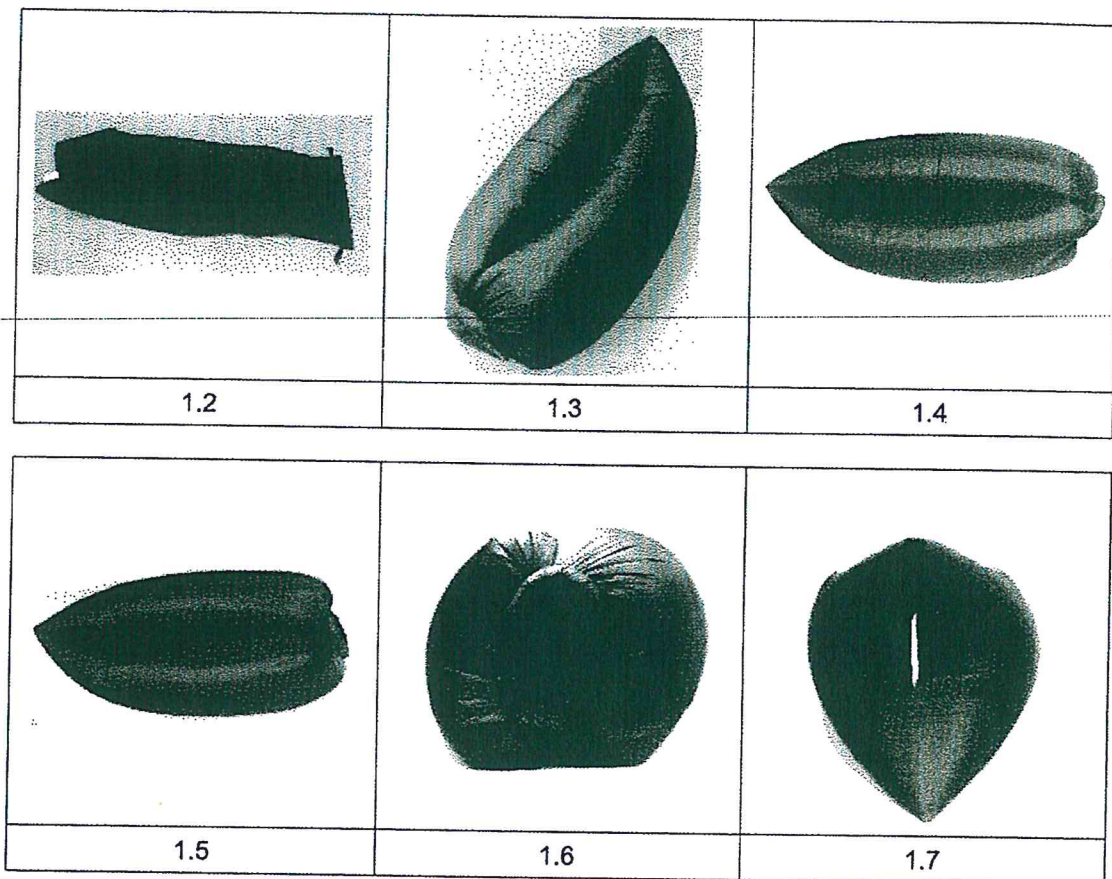

Please note that the images in this document are not necessarily to scale.

The applicant invoked Article 25(1)(b) CDR in conjunction with Article 4(1) and Article 8(1) CDR.

### SUMMARY OF THE PARTIES' ARGUMENTS

The applicant argued that:

- The contested design presented four key features: its overall shape resembled a small boat that was pointed at one end, its side walls were shaped like a sausage ring, it was divided centrally by a longitudinal crease, conveying the impression of a pea pod, and it had a flat end with a circular progressive roller closure.
- These features, individually or in combination, had previously been disclosed, being known and used for identical products; therefore, they were not novel. The earlier 'pea pod' product was present on the platform 'Alibaba' and the earlier 'Cozy Canoe' product, which had all the features of the contested RCD, was disclosed in December 2014 on the internet.
- The key features of the contested design replicated forms that typically occurred in nature (i.e. a pea pod, arm floats, a sausage ring and a bread roll) and could not be registered as a design.



- Moreover, the roller closure could not be protected on account of its technical character. This roller closure mechanism had been disclosed for years in various patents, in particular in European patent application No EP 0 810 950 B1, which was published on 25/04/2001.

In support of its observations, the applicant submitted, inter alia, the following evidence:

- A copy of a screenshot taken from the internet archive Wayback Machine, showing the website [www.walmart.com](http://www.walmart.com) and bearing the date 07/10/2014. A



picture of a lounge appears there as follows:  
(D1).

- A copy of a screenshot taken from the website [www.amazon.com](http://www.amazon.com), showing customer reviews of the product 'Abilitations Inflatable Green Pea Pod Child Calm', next to which are various dates, such as 28/12/2012.
- A copy of a screenshot taken from the website [www.funandfunction.com](http://www.funandfunction.com), showing comments made by users on this website, one of them dated 05/12/2014. The following pictures are displayed:



(D2).

- A copy of a screenshot taken from the website [www.pinterest.com](http://www.pinterest.com), bearing no visible date and displaying the following picture:



(D3).

- An extract from the European Patent Registration No EP 0 810 950 B1, in German, untranslated and published on 25/04/2001, showing the following drawings:

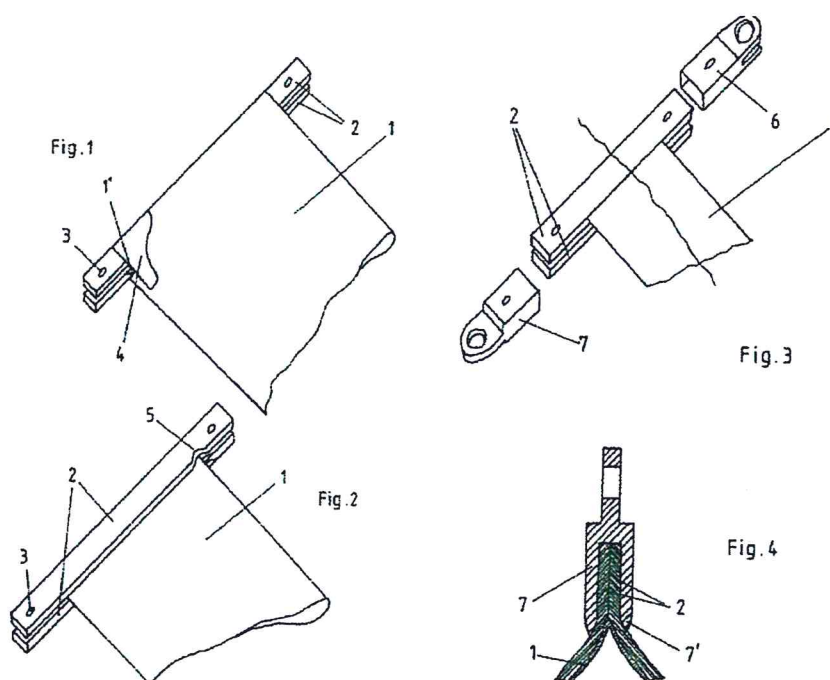

The applicant explained what was protected by this patent registration in its submissions.

The RCD holder argued that:

- It designed the RCD in 2012 and later began selling the 'beanbag chair', which could be filled using the air scooping method, at festivals and on its online store. This design became immensely popular very quickly. Therefore, it registered the contested RCD and filed for a US design patent. As a result of the popularity of the contested design, an immense number of identical or similar products appeared on the market. The courts in the Netherlands, Germany and Denmark have rendered decisions all holding that the contested design was valid and, on that basis, accepted the holder's claims.



- The lack of novelty claimed by the applicant required proof that an earlier design was identical to the RCD, but the prior designs invoked by the applicant, namely the Cozy Canoe (in this decision referred to as D2) and the Pea Pod (in this decision referred to as D1), were not identical to the RCD. Moreover, when comparing the designs as a whole, the Cozy Canoe and the Pea Pod produced different overall impressions on the informed user from the contested design. None of the designs invoked by applicant affected the novelty or individual character of the contested design. This was also the decision reached by the District and the Appeal Court of The Hague, the Netherlands. Therefore, the application for a declaration of invalidity of the RCD should be rejected in its entirety.
- Finally, the contested design produced a different overall impression on the informed user from the earlier designs, which were toys for children with autism (Exhibit 7). These products were objects to hide in and not, as was the purpose of the contested design, to lie on top of. The Cozy Canoe and the Pea Pod both produced the impression of a small boat, an impression that was reinforced by the hand grips. This clearly differed from the contested design,. Furthermore, in the Cozy Canoe and the Pea Pod products, there was a bottom panel in between the side panels, as shown in the following pictures:

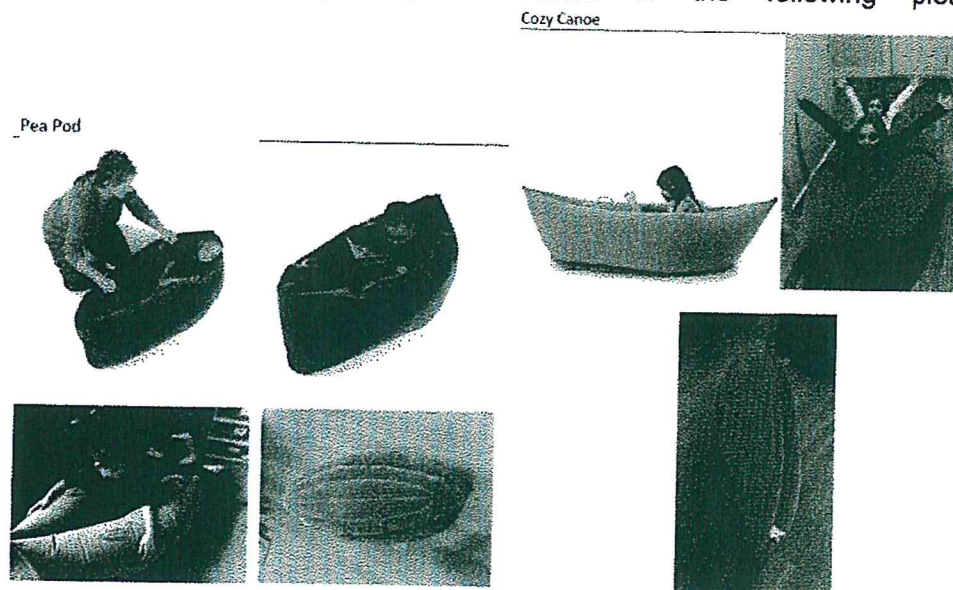

In support of its observations, the RCD holder submitted, inter alia, the following evidence:

- Exhibit 1: extracts from websites, inter alia, [www.facebook.com](http://www.facebook.com), showing the holder's 'LamZac' design, for example:



- Exhibit 2: United States Design Patent registration No US D 764 823 S, which was filed in the name of the holder on 27/07/2015 and showing, inter alia, the

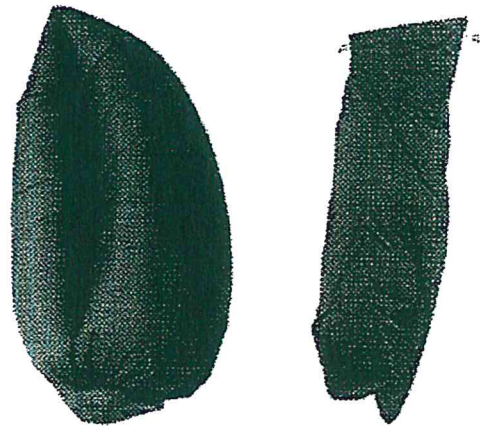

following views of the product:

- Exhibit 7: an extract from the website [www.sensorykidstore.com](http://www.sensorykidstore.com), showing the

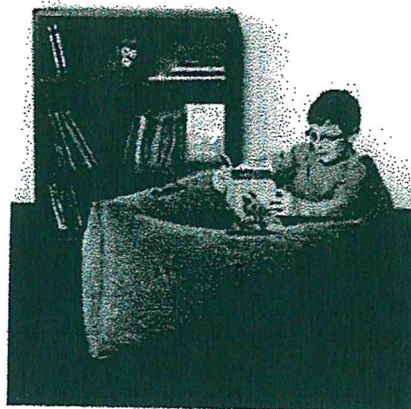

following view of a product:

Both parties submitted further pleadings, which only explained points of view that had already been put forward.

For the sake of completeness, it must be mentioned that in its later submissions the applicant submitted various additional views that were not present in the evidence

submitted with its application; therefore, these additional views cannot be taken into account in the comparison undertaken by the Invalidity Division.

---



**ARTICLE 25(1)(b) CDR IN CONJUNCTION WITH ARTICLE 4 AND ARTICLES 5, 6, 7 AND 8 CDR****a) Disclosure pursuant to Article 7 CDR**

For the purpose of applying Articles 5 and 6 CDR, the tests of novelty and individual character, a design will be deemed to have been made available to the public if it has been published following registration or otherwise, or exhibited, used in trade or otherwise disclosed, before the RCD filing date or the RCD priority date, if a priority is claimed, except where these events could not reasonably have become known in the normal course of business to the circles specialised in the sector concerned, operating within the EU.

The onus is on the invalidity applicant to prove the disclosure of the earlier designs. There are no provisions in the CDR or the CDIR as to the kind or specific form of evidence the invalidity applicant is required to submit to prove that the prior design on which the application for a declaration of invalidity is based has been made available to the public before the relevant date.

Article 28(1)(b)(v) CDIR only states that where the ground for invalidity is that the RCD does not fulfil the requirements set out in Article 5 or 6 CDR, the indication and the reproduction of the prior designs that could form an obstacle to the novelty or individual character of the registered Community design, as well as documents proving the existence of those earlier designs, must be contained in the application.

It follows that, on the one hand, the invalidity applicant is free to choose the evidence it considers useful to submit in support of its application for invalidity and that, on the other hand, the Office is required to examine the evidence in its entirety in order to establish whether there is sufficient proof of a prior disclosure within the meaning of Article 7(1) CDR (09/03/2012, T-450/08, Phials, EU:T:2012:117, § 21-23).

In this regard, the disclosure of an earlier design cannot be proved by means of probabilities or suppositions, but must be based on solid and objective evidence that proves that the earlier design was made available to the public within the meaning of Article 7 CDR (09/03/2012, T-450/08, Phials, EU:T:2012:117, § 24).

With reference to the evidential value of the individual documents, this means that regard should be had first and foremost to the credibility of the content. It is necessary to take account, in particular, of the person from whom the document originates, the circumstances in which it came into being, the person to whom it was addressed and whether, on its face, the document appears sound and reliable (09/03/2012, T-450/08, Phials, EU:T:2012:117, § 23-24, 26).

The case-law further specifies that the items of evidence submitted by the applicant for a declaration of invalidity must be weighed against each other. The reason for this is that, although some of the items of evidence may be insufficient in themselves to demonstrate the disclosure of a prior design, the fact remains that, if they are combined or read in conjunction with other documents or information, they may contribute towards establishing proof of the disclosure (09/03/2012, T-450/08, Phials, EU:T:2012:117, § 25).

In many cases it can be difficult to establish the actual date on which information was in fact made available to the public, however, the date of disclosure on the internet will be considered reliable where information relating to the updates of a web page is available from internet archives.

In the present case, the applicant claimed that the contested design was disclosed on the internet and demonstrated this by submitting a screenshot taken from the website [www.walmart.com](http://www.walmart.com). Although this printout may have been produced after the application date of the Community design at issue, it comes from the Internet Archive (<https://archive.org>) and it is clear from the archiving date that the lounge (the product related to the prior design) illustrated therein was available on the website at least as of 07/10/2014. This document showed the design disclosed as follows:



(D1).

In addition, according to the applicant, the contested design was disclosed on the website [www.funandfunction.com](http://www.funandfunction.com) and on this website there were comments made by users, one of which was dated 05/12/2014. The screenshot of this website showed an offer on an internet retail shop and displayed the following pictures of the product:



(D2).

Although the offer itself does not bear a date, the earliest comment posted below it is dated 05/12/2014. The RCD holder submitted disclosures D1 and D2 in response to the application; therefore, D2 is deemed to have been disclosed at least as of 05/12/2014.

The Invalidity Division considers that date of disclosure is 07/10/2014, which precedes the RCD filing date. The prior design is therefore deemed to be disclosed in compliance with Article 7(1) CDR.

The document showing D3 is undated and therefore cannot be taken into account in the following assessment of the novelty and individual character of the RCD.



**b) Features solely dictated by their technical function pursuant to Article 8(1) CDR**

Article 8(1) CDR denies protection to those features of a product's appearance that were chosen exclusively for the purpose of allowing a product to perform its function, as opposed to features that were chosen, at least to some degree, for the purpose of enhancing the product's appearance.

Aesthetic considerations are, in principle, only relevant when the designer is developing the product's appearance. Most of the time, the designer will be concerned with both elements of good design: functionality and visual appeal. It is only when aesthetic considerations are completely irrelevant that the features of the design are solely dictated by the need to achieve a technical solution (22/10/2009, R 690/2007-3, Chaff cutters, § 35, et seq.).

The fact that a particular feature of a product's appearance is denied protection by Article 8(1) CDR does not mean that the whole design must be declared invalid, pursuant to Article 25(1)(b) CDR. The design as a whole will be invalid only if all the essential features of the appearance of the product in question were solely dictated by its technical function (29/04/2010, R 211/2008-3, Fluid distribution equipment, § 36).

In order to determine whether the essential features of the appearance of the product into which the contested Community design will be incorporated are solely dictated by the technical function of the product, it is first necessary to determine what the technical function of that product is. The relevant indication in the application for registration of the design (Article 36(2) CDR) should be taken into account, but also, where necessary, the design itself, insofar as it makes clear the nature of the product, its intended purpose or its function (18/03/2010, T-9/07, Metal rappers, EU:T:2010:96, § 56).

Whether Article 8(1) CDR applies must be assessed objectively, not in the perception of the informed user, who may have limited knowledge of technical matters.

The contested design is incorporated in inflatable loungers.

The applicant claimed that the technical feature of the contested design that related to the roller closure of the lounge was dictated by the design's technical function and therefore must be completely disregarded in the comparison. To support this claim, the applicant submitted a patent registration document, which referred to some kind of closure but was not translated. Moreover, in its later submissions of 10/01/2017, the applicant further elaborated on this issue, claiming that the entire design (namely its double tubular shape and plain surface, as well as the roller closure mechanism) was dictated purely by its technical function and should be invalidated.

The Invalidity Division considers that the applicant has not submitted any convincing evidence to demonstrate that the inflatable lounge or any of its essential features have been chosen with a view to designing the product solely for the purpose of enhancing the product's technical function.

First, the patent documents were not translated into the language of the proceedings. Mere allegations without any kind of evidence are insufficient.

It might be true, as argued the applicant, that the roller closure, the tubular shape and plain surface of the contested design were indeed related to the function and purpose of the safe closure of the lounge and for the possibility of lying on it. However, no



evidence was submitted to indicate that these functions and purposes were the sole determinant of the presence of these elements in the product.

The fact that other companies try to develop air-filled sofas that use the air scooping mechanism and that are of the same shape as the earlier designs, as claimed by the applicant, does not change this outcome.

In the light of the foregoing, it cannot be concluded that the contested RCD should be declared invalid under Article 8(1) CDR. To this extent the invalidity application must be rejected.

For the sake of completeness, the Invalidity Division will evaluate the designer's degree of freedom in creating the design in relation to the essential features of the product in the overall assessment below.

**c) Novelty pursuant to Article 5 CDR**

Article 5(1)(b) CDR provides that a registered Community design must be considered to be new if no identical design has been made available to the public before the date of filing of the application for registration of the design for which protection is claimed or, if priority is claimed, the date of priority. Article 5(2) CDR provides that designs must be deemed to be identical if their features differ only in immaterial details.

The designs under comparison are shown below with corresponding views:

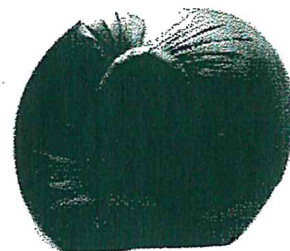
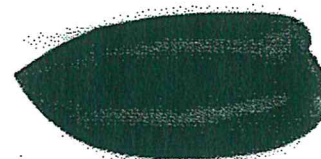
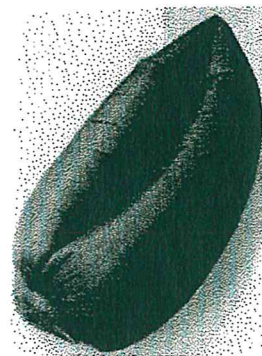
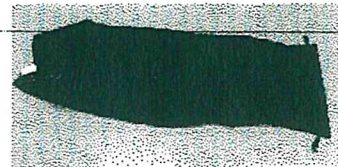
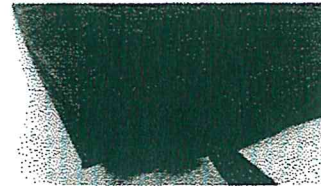

Prior designs (D1 and D2)

Contested design



All of the products compared are inflatable lounge bags. They are of a elongated oval shape, have a surface to lie on or in and have a trench extending along the lounge bag when inflated.

Despite these similarities, the products differ in a variety of characteristics.

The end of the bag of the contested RCD becomes oval in shape when inflated and the other end of the bag is rectangular. However, both ends of the earlier designs seem to be rectangular. Moreover, the ends of earlier design D2 sharply extend upwards. The same can be said of earlier design D1, albeit the extension is not as sharp as in D2. This feature is non-existent in the contested design.

Furthermore, the oval end of the contested design is where the roller closure mechanism is placed, whereas the earlier design does not have this feature.

Even though all of the products have a trench extending along the lounge bag when inflated, it is apparent that this trench in the contested design is not deep and is tight enough to for it to be lain on. However, in the earlier designs, the trench is wide and loose enough to divide the bag into two parts, allowing the user to sit inside the bag, rather than to lie on its surface. This feature is supported by the additional four handles in the earlier designs, which are placed alongside the trench, so that the person sitting inside the lounge can lift themselves up.

Moreover, the contested design has an additional white decorative tag that is not present in the earlier designs.

It cannot be safely concluded that these differing features are immaterial.

Taking the above into account, the Invalidity Division finds that the prior designs are not identical to the contested RCD. In other words, the differing features of the compared designs, listed above, cannot be regarded as being 'immaterial'. The ground based on Article 5 CDR must therefore be rejected as unfounded.

#### **d) Individual character pursuant to Article 6 CDR**

Under Article 6(1)(b) CDR, a registered Community design must be considered to have individual character if the overall impression it produces on the informed user differs from the overall impression produced on such a user by any design that has been made available to the public before the date of filing of the application for registration of the design for which protection is claimed or, if priority is claimed, the date of priority. Article 6(2) CDR states that, in assessing that individual character, the degree of freedom of the designer in developing the design must be taken into consideration.

Recital 14 CDR provides that, when assessing whether a design has individual character with respect to the existing design corpus, it is necessary to take into consideration the nature of the product to which the design is applied or in which it is incorporated, and in particular the industrial sector to which it belongs.

It follows from the above that the assessment of the individual character of a Community design with respect to any earlier design disclosed to the public must, in essence, proceed from a four-step review:

- the sector of products in which the compared designs are incorporated or to which they are applied,



- the informed user of the products according to their purpose and, in reference to the informed user:
  - the degree of knowledge of the state of the art, and
  - the degree of attention in the comparison, direct if possible, of the designs,
- the degree of freedom of the designer in the development of the designs, and
- the result of the comparison of the designs, taking into account the overall impressions produced on the user by the contested design and any of the earlier designs. The assessment should not be simply an analytical comparison of a list of similarities and differences (18/03/2010, T-9/07, Metal rappers, EU:T:2010:96, § 54-84; 20/10/2011, C-281/10 P, Metal rappers, EU:C:2011:679, § 53-59; 07/11/2013, T-666/11, Gatto domestico, EU:T:2013:584, § 21).

The comparison should focus on the contested design as registered and must be based on the elements that are actually protected, without regard to the features excluded from the protection (14/06/2011 T-68/10, Watches, EU:T:2011:269, § 74; 07/11/2013, T-666/11, Gatto domestico, EU:T:2013:584, § 30).

The designer's degree of freedom in developing a design is established, inter alia, by the constraints of the features imposed by the technical function of the product or an element thereof, or by statutory requirements applicable to the product. Those constraints result in a standardisation of certain features, which will thus be common to the designs applied to the product concerned (09/09/2011, T-10/08 and T-11/08, Internal combustion engine, EU:T:2011:447, § 32, 47; 18/03/2010, T-9/07, Metal rappers, EU:T:2010:96, § 67).

The General Court has refused to allow a general design trend to be regarded as a factor that restricts the designer's freedom, since it is precisely that freedom on the part of the designer that allows him to discover new shapes and new trends or even to innovate in the context of an existing trend (13/11/2012, T-83/11 and T-84/11, Radiators for heating, EU:T:2014:115, § 95).

When assessing the individual character of a design taking into account the existing design corpus, the degree of freedom of the designer in developing the design may be such as to make informed users more sensitive to differences between the designs under comparison (13/11/2012, T-83/11 and T-84/11, Radiators for heating, EU:T:2014:115, § 81), as may the manner in which the product at issue is used, in particular the way it is usually handled (22/06/2010, T-153/08, Communications equipment, EU:T:2010:248, § 66; 07/11/2013, T-666/11, Gatto domestico, EU:T:2013:584, § 30).

The informed user is a legal fiction that must be understood, depending on each case, as an intermediate concept between the average consumer, applicable in trade mark matters, of whom no specific knowledge is required and who, in general, does not perform a direct comparison between the marks, and the man of the art, applicable in the field of patents, an expert endowed with extensive technical skills and exhibiting a very high degree of attention when directly comparing conflicting inventions (18/03/2010, T-9/07, Metal rappers, EU:T:2010:96, § 53; 25/04/2013, T-80/10, Montres, EU:T:2013:214, § 100). Therefore, a low level of knowledge and a low degree of attention, bringing the informed user closer to the average consumer and further away from the man of the art, reinforce the conclusion that designs that do not present significant differences in the features in which the designer's freedom is unrestricted



produce the same overall impression on the informed user (09/09/2011, T-11/08, Internal combustion engine, EU:T:2011:447, § 33). In such cases, the contested design must be declared invalid due to lack of individual character or, as the case may be, because the allegedly infringing design actually infringes the exclusive right of the holder. A high degree of knowledge and a high degree of attention in the informed user reinforce the opposite conclusion (07/11/2013, T-666/11, Gatto domestico, EU:T:2013:584, § 31).

Pursuant to Article 63(1) CDR, in invalidity proceedings, the Invalidity Division is restricted to examining the facts, evidence and arguments submitted by the parties and the relief sought. The Invalidity Division therefore does not carry out its own research. This, however, does not preclude it from also taking into consideration facts that are well known, that is, that are likely to be known by anyone or can be learned from generally accessible sources.

The facts and arguments in a particular case, in principle, must have been known before the RCD; however, facts relating to the design corpus, the density of the market or the designer's freedom should precede the date of disclosure of the prior design.

#### *The sector concerned and the informed user*

The contested design is incorporated in an inflatable *chaise longue* and the earlier designs (D1 and D2) are incorporated in *inflatable calming stations*. The informed user is therefore a person who is familiar with inflatable furniture products intended for lounging and relaxing.

The informed user is aware of characteristic features of the products concerned, in particular that they must be inflatable and deflatable, be of a long oval shape and have a surface to lie on or in.

As these types of products are casual purchases rather than specialised or high-value products, and because they are portable rather than permanent furniture, the attention of the informed user will not be exceptionally high. The informed user will be able to compare the designs side by side.

#### *The freedom of the designer*

A designer's degree of freedom in the case of these types of *chaise longue* or of an *inflatable calming station* is restricted only insofar as they must be ergonomic enough for a person to sit or lie on or in them, it must be possible to use the air scooping method to fill them and they must be capable of being closed, packed and stored economically.

Consequently, the designer's freedom within the meaning of Article 6(2) CDR is not, in this connection, substantially limited. The shapes, forms, materials and accessories may vary product by product. In accordance with the case-law cited, only minor differences between the prior and the contested designs will be insufficient to produce different overall impressions on the informed user.

#### *The overall impression*

The applicant argued that the RCD lacked individual character because it had the same shape (resembling a small boat that was pointed at one end), the same shaped side walls (resembling a sausage ring), was centrally divided in the same way (by a longitudinal crease) and conveyed the same impression of a pea pod as the prior



designs. The applicant further argued that the contested design's flat end with a circular progressive roller closure had already been disclosed and was limited by its technical function.

The Invalidity Division cannot agree with these arguments.

First, it should be pointed out that the prior designs and the RCD have in common their elongated shape and the fact that they have a surface to lie or sit on or in, as well as the fact that they can be inflated and deflated. All these characteristics are well known and ordinary and therefore will be viewed as banal by the informed user.

The informed user will pay more attention to the details, as regards the shape and form, that differ from this standard. These features are the dividing line of the loungers (the trench), the particular shape of the products when they are inflated, the ends of the loungers and the closure mechanism.



Earlier designs D1 ( ) and D2 ( ) are both incorporated in calming or relaxing stations for children. They have a deep trench that extends along the whole length of the bag, which is intended to allow a person to sit inside it. They resemble a boat or a canoe, as can particularly be seen in D2. However, the surface of the contested design has a tight trench that only lets a person lie on the bag.

Moreover, the Invalidity Division has identified several other differences between the designs compared (see the section on novelty in this decision), allowing it to be concluded that the contested design enjoys individual character, even though the designer's degree of freedom is not substantially limited.

The Invalidity Division identifies even more differences when the contested design is compared with earlier design D2, the top corners of which extend sharply upwards, resembling a boat or a canoe, as claimed by the applicant itself. This feature is not present in the contested designs, the ends of which are symmetrical and extend to the same point at the top and bottom.

In addition, one end of the contested design is rounded, due to its closing mechanism. This feature is not seen in either of the earlier designs. Finally, earlier designs D1 and D2 have handles, but handles are not visible in the views of the contested design, and the contested design also has an additional tag.

Moreover, these types of products can vary in their types of closure. The contested design has a roller closure mechanism, which is not seen at the designs disclosed, but this patent document does not show any whole product resembling the contested design. which is not contained in the earlier designs disclosed; in addition, the patent document submitted in relation to the closure in the earlier designs does not show a product as a whole that resembles the contested design.



Taking all of the above into account, in the Invalidity Division's view, the contested design departs from the prior designs in those features in which the designer had freedom and developed the design.

In the light of the foregoing, it is concluded that the contested RCD, in respect of the overall impression that it produces on the informed user, departs from both of the prior designs invoked. As a result, the RCD has individual character in the sense of Article 6(1)(b) CDR.

## CONCLUSION

The facts and evidence submitted by the applicant do not support the grounds for invalidity under Article 25(1)(b) CDR; therefore, the application is rejected.

## COSTS

According to Article 70(1) CDR, the losing party in invalidity proceedings must bear the fees and costs incurred by the other party.

Since the applicant is the losing party, it must bear the costs incurred by the holder in the course of these proceedings.

According to Article 70(1) CDR and Article 79(7)(f) CDIR, the costs to be paid to the holder are the costs of representation, which are to be fixed on the basis of the maximum rate set therein.



### The Invalidity Division

Ludmila ČELISOVA

Gailė SAKALAITĖ

Michele M.  
BENEDETTI-ALOISI

According to Article 56 CDR, any party adversely affected by this decision has a right to appeal against this decision. According to Article 57 CDR, notice of appeal must be filed in writing at the Office within two months of the date of notification of this decision. Furthermore, a written statement of the grounds of appeal must be filed within four months of the same date. The notice of appeal will be deemed to have been filed only when the appeal fee of EUR 800 has been paid.

The amount determined in the fixing of costs may only be reviewed on request. According to Article 79(4) CDIR, such a request must be filed within one month from the date of notification of this fixing of costs and will be deemed to have been filed only when the review fee of EUR 100 has been paid (Annex to CDFR, § 24).